



**TRANSMISSION  
SERVICE  
TECHNOLOGY**

T-TECH EXPRESS  
TRANSMISSION  
FLUID EXCHANGE  
TT100

**TT100  
USER'S GUIDE**

# SAFETY SUMMARY

Congratulations on the purchase of your new **T-TECH** Transmission Fluid Exchange System. The following safety information is provided as a guideline to help you operate your new transmission fluid exchange system under the safest possible conditions. Any equipment can be potentially dangerous to use when safety or safe handling instructions are not known or not followed.

A procedure step preceded by **WARNING** is an indication that the step contains a procedure that might be injurious to a person if proper safety precautions are not heeded. A procedure step preceded by **CAUTION** is an indication that the step contains a procedure that might damage the equipment being used.





## Safety Instructions

Tools are dangerous if misused or abused. To reduce risk of discomfort, illness, injury or even death, read, understand, and follow these following safety instructions. In addition, make certain that anyone else that uses this equipment understands and follows these safety instructions as well.

**Retain these instructions for future reference.** Read all safety instructions carefully before attempting to install, operate or service this equipment. Failure to comply with these instructions could result in personal injury and/or property damage. Published standards on safety are also available. For additional information concerning safety, refer to the following standards and comply with them, as applicable.

ANSI Standard Z87.1 — SAFE PRACTICE FOR OCCUPATION AND EDUCATIONAL EYE AND FACE PROTECTION — obtainable from the American National Standards Institute, 1430 Broadway, New York, NY 10018

The following safety alert symbols identify important safety messages in this manual. When you see one of the symbols shown here, be alert to the possibility of personal injury and carefully read the message that follows.

<b>⚠ WARNING</b>	
	Read these instructions completely before using the <b>T-TECH</b> and save them for future reference. Before using the <b>T-TECH</b> , read these instructions and the instruction manual/safety information provided by the car, truck, boat or equipment manufacturer. Following all manufacturers' instructions and safety procedures will reduce the risk of accident.
	All lead-acid batteries (car, truck and boat) produce hydrogen gas which may violently explode in the presence of fire or sparks. <b>Do not smoke, use matches or a cigarette lighter while near batteries.</b> Do not handle the battery while wearing vinyl clothing because static electricity sparks are generated when vinyl clothing is rubbed. Review all cautionary material on the <b>T-TECH</b> and in the engine compartment.
	Always wear eye protection, appropriate protective clothing and other safety equipment when working near lead-acid batteries. Do not touch eyes while working on or around lead-acid batteries.
	Use extreme care while working within the engine compartment, because moving parts may cause severe injury. Read and follow all safety instructions published in the vehicle's Owner's Manual.

<b>⚠ WARNING – MOTION HAZARDS</b>	
	Engine parts that are in motion can cause serious injury or death. When working near moving engine parts, wear snug fit clothing and keep hands, fingers and hair away from moving parts. Keep hoses and tools clear of moving parts. Hoses and tools can be thrown through the air if not kept clear of moving engine parts. Never wear loose fitting clothing or allow long hair to be exposed to the engine compartment. The unexpected movement of a vehicle can cause serious injury or death. When working on a vehicle, always set the parking brake or block the wheels of the vehicle being serviced.

### ⚠️ WARNING – FLUIDS UNDER PRESSURE



Hot transmission fluid, under pressure, can injure the eyes. **Always wear eye protection** (safety glasses) when opening transmission lines to protect the eyes against hot fluids being forcefully sprayed into them. Ordinary glasses do not have impact resistant lenses, they are NOT safety glasses. Always clean up transmission fluid spills immediately. Transmission fluid is very slippery when spilled.

### ⚠️ WARNING – HEAT HAZARDS



Vehicle transmissions can be very hot and the fluid is under pressure when the vehicle is running. Opening a hot, pressurized transmission line can cause hot transmission fluid to be forcibly sprayed in all directions. Wait until the engine has cooled in the vehicle being serviced before removing a system line or in any way opening the vehicle transmission system when the system is hot and under pressure.

Many component parts, in a vehicle that has been running, are hot and can cause serious skin burns. Take care to not touch hot components. Wait until the vehicle has cooled before attempting to service.

### ⚠️ WARNING – POISONOUS FLUID HAZARDS



This fluid exchanger is intended for **transmission fluid only**. Transmission fluid is poisonous if ingested. Ingesting transmission fluid can cause serious illness. Keep transmission fluid where children and pets cannot get to it. If some transmission fluid should be accidentally swallowed, take the person or pet in for medical assistance immediately. Be sure to identify to the doctor specifically what it was that was ingested. If medical assistance is not immediately available, call the local poison center. Avoid contact with skin and eyes. If skin contact is made, flush affected area with water and wash immediately. For eye contact, flush with water and apply a suitable eye wash. If irritation persists, contact a physician.

### ⚠️ WARNING – FUME HAZARDS



#### **FUMES, GASSES, AND VAPORS CAN CAUSE DISCOMFORT, ILLNESS, AND DEATH!**

Breathing vehicle exhaust emissions can cause sickness, injury, or death. Always work in a properly ventilated area when servicing a vehicle with the engine running. Never run an engine without proper ventilation for its exhaust.

Stop the exchange process if you develop momentary eye, nose, or throat irritation. Eye, nose, or throat irritation indicates inadequate ventilation. Stop work and take necessary steps to improve ventilation in the work area.

### ⚠️ WARNING – EXPLOSION HAZARDS



**A BATTERY EXPLOSION CAN INJURE, AND CAUSE PROPERTY DAMAGE!** A spark near a battery can cause an explosion. To reduce the risk of a spark near a battery, make the positive connection to the battery first then the negative connection to the vehicle chassis, at a point away from the battery.

### ⚠️ WARNING – TIP OVER HAZARDS



Do not tip or rock the **T-TECH**. Such actions could result in serious injury or property damage. Always lock the wheels when stationary to avoid unintentional movement of the **T-TECH**.

**WARNING:** This product contains chemicals, including lead, known to the State of California to cause cancer, birth defects and other reproductive harm. **Wash hands after handling.**

# TABLE OF CONTENTS

## SAFETY SUMMARY

Safety Instructions .....	2
<i>Additional Safety Information</i> .....	2
<i>Fluids Under Pressure</i> .....	2
<i>Motion Hazards</i> .....	2
<i>Shock Hazards</i> .....	3
<i>Heat Hazards</i> .....	3
<i>Poisonous Fluid Hazards</i> .....	3
<i>Fume Hazards</i> .....	3
<i>Explosion Hazards</i> .....	3
<i>Tip Over Hazards</i> .....	3

## INTRODUCTION

About This MANUAL .....	6
The T-TECH Process .....	6
<i>T-Tech Specifications</i> .....	6

## PREPARATION FOR USE

Fitting Organization .....	7
<i>Standard Fittings Assortment Descriptions</i> .....	7
<i>Cabinet Drawer Storage Layouts</i> .....	9
<i>Special Fittings Kits</i> .....	10
Removing Air From Cylinder .....	12

## OPERATION INSTRUCTIONS

Overview .....	13
Fill Cylinder Function .....	14
<i>Using a Bulk Dispenser Gun</i> .....	14
Connecting to the Vehicle .....	15
<i>Identifying Cooling Lines</i> .....	15
<i>Making Vehicle Service Connections</i> .....	15
Fluid Exchange Function .....	17
<i>Bypass Feature</i> .....	18
Replace Existing New ATF with Different New ATF .....	18

## MAINTENANCE

General .....	19
Troubleshooting .....	19

## T-TECH APPLICATION NOTES

<b>General</b>	<b>.21</b>
<b>BMW</b>	<b>.21</b>
<i>BMW General</i>	.21
<i>BMW 500 Series</i>	.21
<b>Chrysler</b>	<b>.21</b>
<i>Dodge Dakota (to 1997) and some Ram</i>	.22
<i>Dodge Ram (Pre-2004 Assorted Gasoline engines only)</i>	.22
<i>Some Dodge Durango and Dakota 1997-2004</i>	.23
<i>Jeep Grand Cherokee</i>	.23
<b>Ford</b>	<b>.23</b>
<i>Ford Contour</i>	.24
<i>Ford Escort</i>	.24
<i>Ford Explorer</i>	.24
<i>Ford F-Series Trucks</i>	.25
<i>Ford Taurus &amp; Windstar</i>	.26
<i>Ford Windstar</i>	.26
<i>Mercury Mountaineer</i>	.27
<i>Mercury Mystique</i>	.27
<i>Mercury Sable</i>	.27
<b>General Motors</b>	<b>.27</b>
<i>Quick-Disconnect Equipped Vehicles</i>	.27
<i>Allison Series 1000</i>	.28
<b>Mazda</b>	<b>.28</b>
<b>Mercedes-Benz</b>	<b>.29</b>
<b>Nissan</b>	<b>.29</b>
<b>Saab</b>	<b>.29</b>
<b>Toyota</b>	<b>.30</b>
<b>Volkswagen Products</b>	<b>.30</b>
<b>Volvo</b>	<b>.30</b>

## REPLACEMENT PARTS LIST

<b>External Parts List</b>	<b>.31</b>
<b>Internal Parts List</b>	<b>.33</b>
<b>Fittings &amp; Tools</b>	<b>.35</b>

## PLUMBING DIAGRAM . . . . .36

## WARRANTY . . . . .37

# INTRODUCTION

## About This Manual

This manual includes a *Safety Summary, Operating Procedures, Machine Preparation, Maintenance Instructions and Troubleshooting Procedures* for transmission fluid exchanging. Anyone intending to use this machine should become familiar with all the information included in this manual (especially the Safety Summary) before attempting to use the Transmission Fluid Exchanger. In order to properly perform a complete transmission fluid exchange, follow all procedures in the order presented. Please take the time to study this manual before operating the machine. Then keep this manual close at hand for future reference.

## The T-TECH Process

Heat is the enemy of transmission fluid. Transmission fluid is a combination of light base oils with an extensive additive package to control foaming, slip, lubrication, etc. Heat attacks the additive package and oxidizes or burns it away, leaving you with only the base oils.

In order to slow the oxidation of the additive package, the vehicle manufacturers have designed an oil cooler, usually in the radiator, that passes all of the transmission fluid through it.

**T-TECH** uses a patented process of harnessing the pump in the vehicle's transmission to control the flow of fluid. This process captures the fluid coming out of the transmission and automatically directs it into the bottom of the **T-TECH** cylinder. The used ATF flowing into the bottom of the cylinder pushes against the separating piston and directs new fluid out the top of the cylinder and back into the vehicle.

The patented **T-TECH** system makes it IMPOSSIBLE TO HARM A VEHICLE'S TRANSMISSION. The **T-TECH** process operates exclusively on the transmission pump pressure, which essentially eliminates the possibility of over-pressure, under-pressure, overfill or underfill.

**T-TECH** Fluid Exchange is the preferred method of automatic transmission service because it is designed to offer the safest and most complete exchange of fluid in the transmission, torque converter, lines and cooler.

The need for a safe and thorough exchange of used ATF has increased as the life expectancy of vehicles increases, the demands placed on these vehicles grows and the cost of repair rises. Today, nearly every vehicle has an OEM-recommended service for automatic transmissions.

The original pan drop method of service only captured 30% - 40% of the vehicle's used ATF. Other mechanical exchange machines force fluid into the vehicle under pressure and can damage the seals inside a transmission.

Discover why vehicle owners throughout North America specify **T-TECH** when asking for ATF service

## T-TECH Specifications

<b>Max Pressure:</b>	85 psi, 583 kPa
<b>Weight (approx.):</b>	96 lbs. (43.54 kg)
<b>Depth:</b>	32.5 in. (0.83 m)
<b>Width:</b>	21.5 in. (0.55 m)
<b>Height:</b>	51.5 in. (1.31 m)
<b>Patents:</b>	5,318,080, Re. 38,650; 6,082,416; 6,267,160; 6,330,934

*Note: Do not leave your **T-TECH** in direct sunlight in extremely hot temperatures (>90°F) for extended periods. Such exposure can have detrimental effects on the case.*

# PREPARATION FOR USE

Although minimal, **T-TECH** requires some preparation before use. The following instructions describe the necessary steps to prepare your new transmission fluid exchanger for use.

## Fitting Organization

Locate the standard fittings assortment and set each fitting in the **T-TECH** cabinet storage position identified by the picture mounted on the backside of the cabinet cover. The standard fittings have a specific storage location inside the **T-TECH** cabinet. Most of the fittings are numerically referenced and have a color-coded band for easy identification.

Throughout each of the operating functions performed using the **T-TECH**, various adapters, fittings, or attachments will require installation in order to service a specific vehicle. This is not considered part of initial preparation for use. In each case, the setup and connection requirements for a specific task will be added, where necessary, as part of the procedure for that task.

## Standard Fittings Assortment Descriptions

Figure 1 through Figure 14 identify the fittings/components in the standard fittings assortment.

*Note: Be aware that any of these fittings along with any of the fittings in the special fittings kits can be used to service any vehicle as needed.*

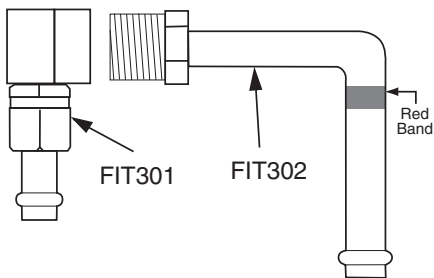

Figure 1. Fitting 301 and Fitting 302  
General Motors – Pre-2000 large and heavy-duty GM cars, trucks and vans

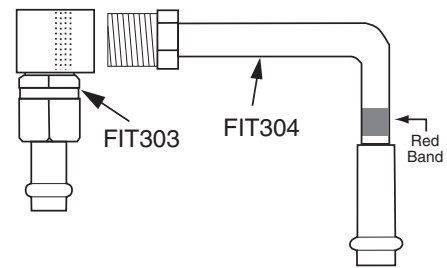

Figure 2. Fitting 303 and Fitting 304  
General Motors – Pre-2000 passenger cars, light duty trucks and vans

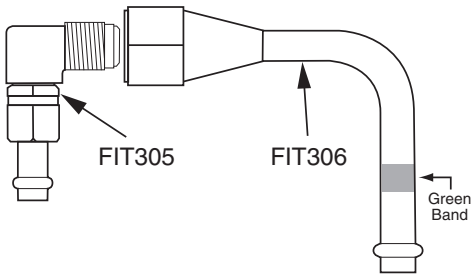

Figure 3. Fitting 305 and Fitting 306  
Chrysler/Jeep/Eagle – Pre-2005 Jeep Cherokee and some passenger vehicles

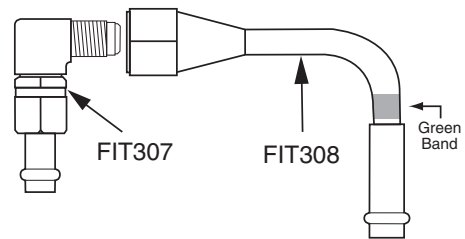

Figure 4. Fitting 307 and Fitting 308  
Chrysler/Dodge/Eagle – Chrysler Corp. passenger cars [Fitting 308 also fits Volvo 720/740]

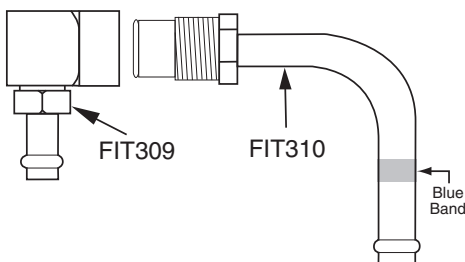

Figure 5. Fitting 309 and Fitting 310  
Ford – Pre-2005 large trucks and vans

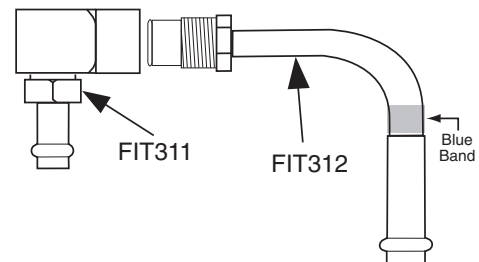

Figure 6. Fitting 311 and Fitting 312  
Ford – Small passenger cars and light duty trucks

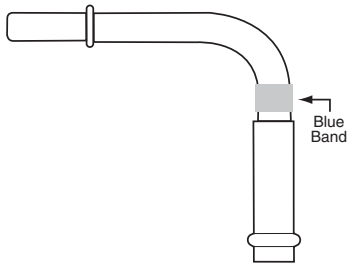

Figure 7. Fitting 314  
 Ford/Lincoln/Mercury – Fits earlier Ford, Lincoln, and Mercury small and large passenger vehicles

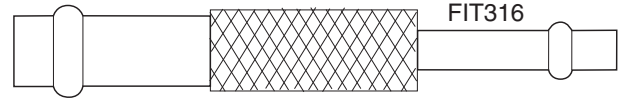
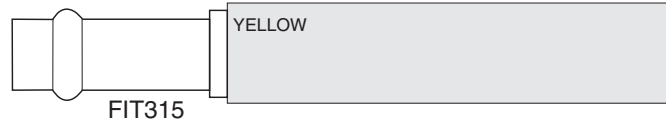

Figure 8. Fitting 315 and Fitting 316  
 Any vehicle with 1/4 inch hose connections

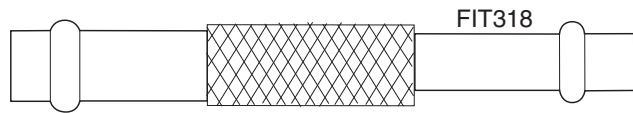
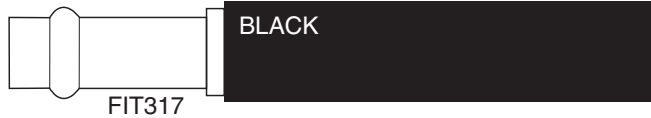

Figure 9. Fitting 317 and Fitting 318  
 Any vehicle with 5/16 inch hose connections



Figure 10. Fitting 319  
 Any vehicle with 3/8 inch hose connections

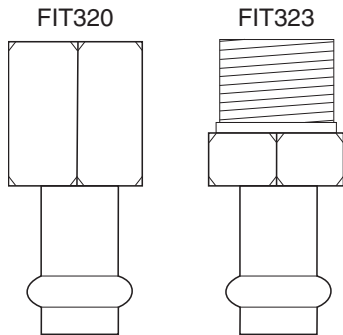

Figure 11. Fitting 320 and Fitting 323  
 Any vehicle with 1/4 inch pipe fittings. Sometimes used to bypass quick connect receptacles

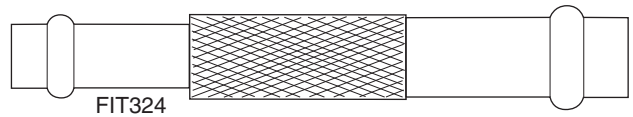

Figure 12. Fitting 321 and 324  
 Any vehicle with 1/2 inch hose connections

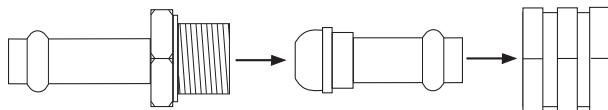

Figure 13. Fitting 322  
 Mercedes Benz and some BMW

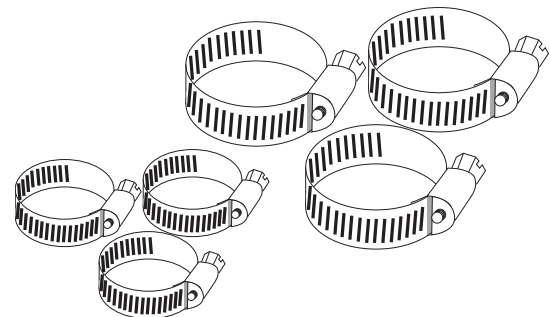

Figure 14. Hose Clamps in two sizes, three each



## Cabinet Drawer Storage Layouts

The storage trays in the **T-TECH** cabinet are defined in Figure 15. Figure 16 and Figure 17 show the tray layout for storage of the standard fittings in trays 3 and 4 respectively. The numbers shown in the illustration are the specific fitting number for the standard fittings and will be referred to throughout this manual.

*Note: The numbers in Figures 16 and 17 correspond to standard fittings FIT301-FIT324. (There is no fitting numbered FIT313.)*

Figure 15.

1. Special Fittings Tray
2. Special Fittings Tray
3. Standard Fittings Tray
4. Standard Fittings Tray
5. Storage for Manual

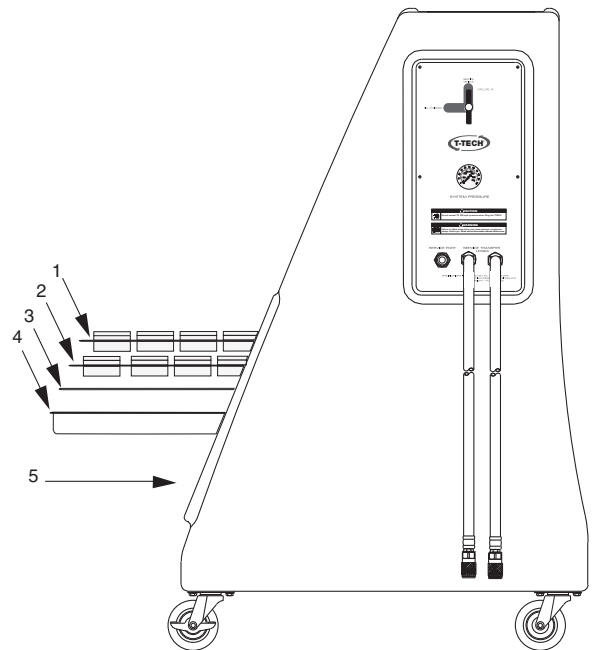

Figure 15. **T-TECH** cabinet organization

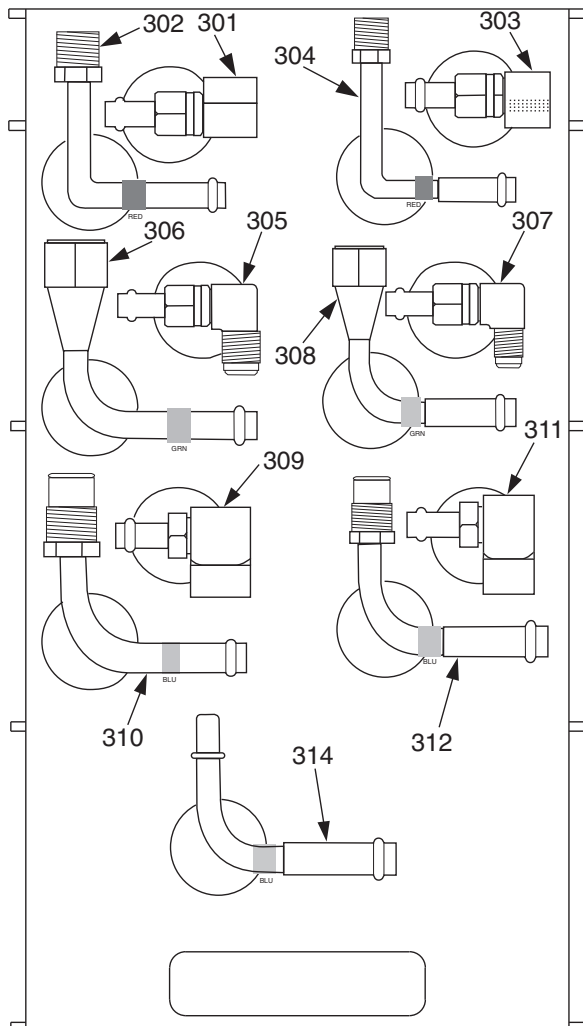

Figure 16. Standard Fittings Storage Tray (3)

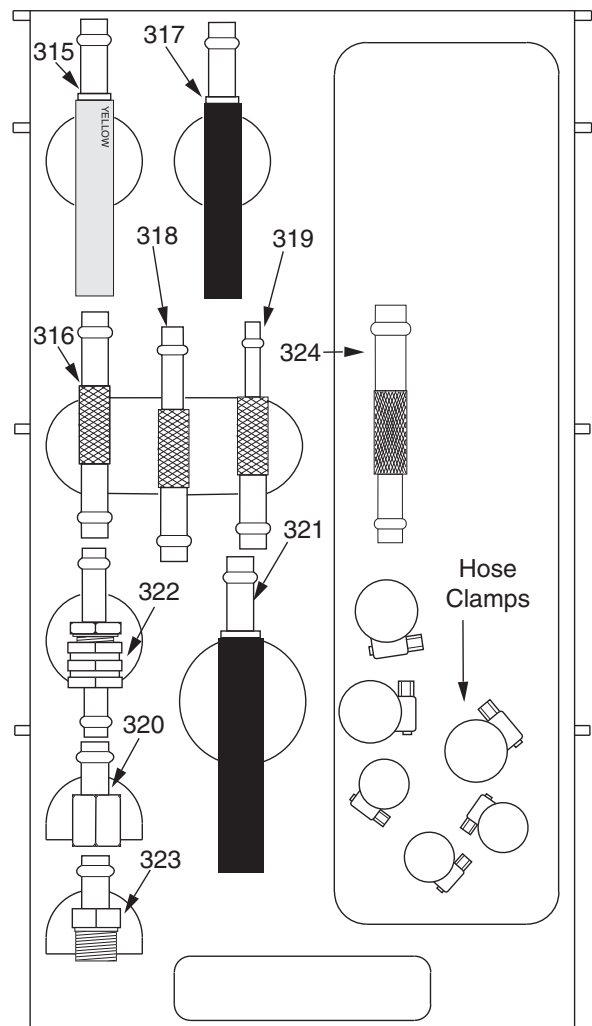

Figure 17. Standard Fittings Storage Tray (4)

## Special Fittings Kits

Optional accessories on TT100 must be ordered separately. The special fittings shown in Figure 18 through Figure 34 are stored in small plastic cases (Figure 18) in trays 1 and 2, inside the **T-TECH** cabinet (Figure 15).

**CAUTION:** Each of the special fittings kits displayed here is a unique matched set of fittings intended for special use. Always keep the fittings in each kit together. When the fittings in these kits become mismatched, it is possible to damage the fittings or the vehicle.

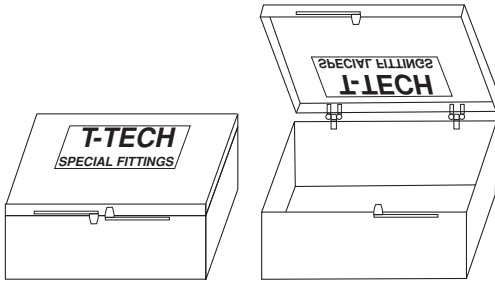

Figure 18. FIT165

Replacement plastic storage cases for Special Fittings Kits

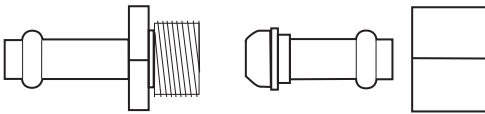

Figure 20. FIT402  
BMW



Figure 22. FIT404  
3/8" Quick Connect, GM/Chrysler



Figure 24. FIT406  
Ford/Dodge

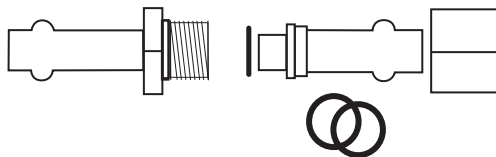

Figure 26. FIT408  
Ford Contour/Mercury Mystique

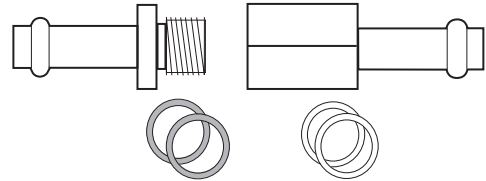

Figure 19. FIT401  
Ford Escort/Nissan/Mazda

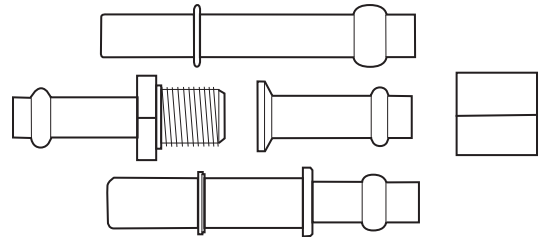

Figure 21. FIT403  
Ford Taurus/Dodge Full Size Trucks

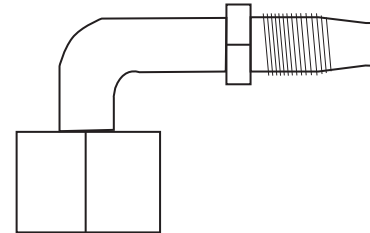

Figure 23. FIT405  
Some Jeep/Chrysler

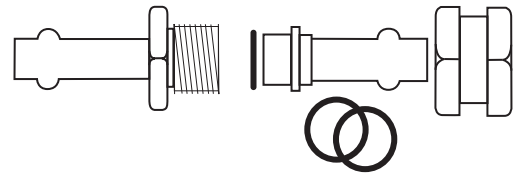

Figure 25. FIT407  
BMW 5 Series and 3 Series

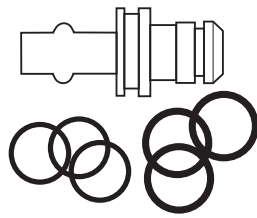

Figure 27. FIT409  
Volvo

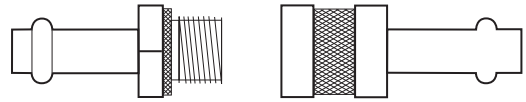

Figure 28. FIT410  
Saab

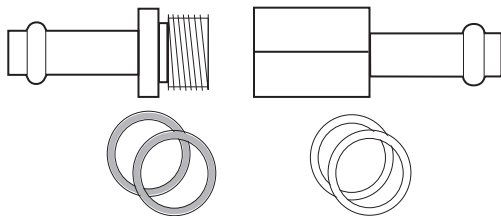

Figure 29. FIT411  
Mazda/Ford Banjo Fittings

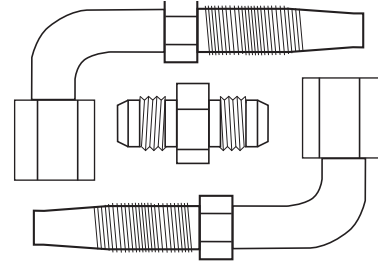

Figure 30. FIT412  
Pre-2005 Dodge Durango/Dakota

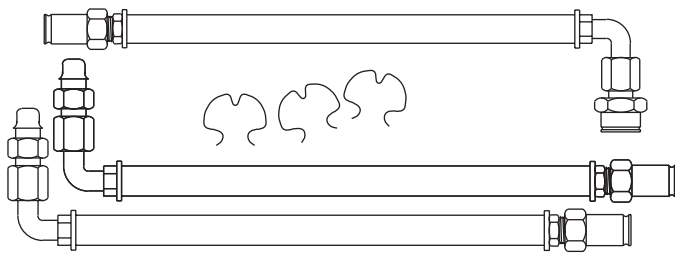

Figure 31. FIT413  
Allison 1000 Series

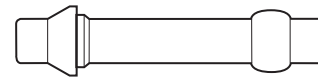

Figure 32. FIT414  
3/8" Quick Connect, Ford

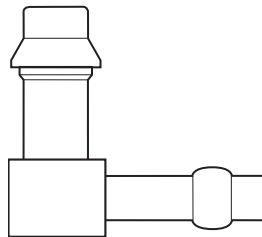

Figure 33. FIT415  
90° 1/2" Quick Connect, Ford

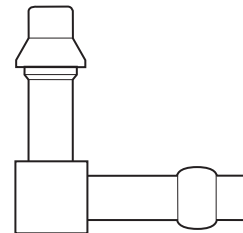

Figure 34. FIT416  
90° 3/8" Quick Connect, GM/Chrysler

## Removing Air From the Cylinder

When using the **T-TECH** for the first time, there may be space at the top of the cylinder (air in the cylinder). If not corrected, this condition may short future exchanges. If for some reason the piston is at the bottom of the cylinder, or there is large air pocket above the piston, the piston can be moved to the top of the cylinder by the following method.

1. Set CONTROL VALVE to SERVICE VEHICLE.
2. Attach a service hose adapter to one of the service transfer hoses.
3. Insert an air nozzle into the end of the service hose adapter.
4. Control the air line at 10 psi (138 kPa) or less and begin filling the bottom of the cylinder with air.

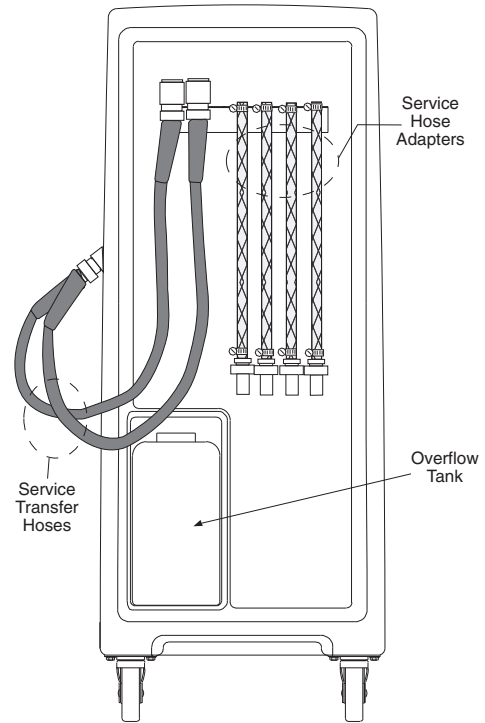

Figure 35. Hoses and Hose Adapters

# OPERATION INSTRUCTIONS



For first time use, do not perform any of the following procedures until you have completed the procedures in *Preparation For Use*. All procedures must be performed in the order presented.

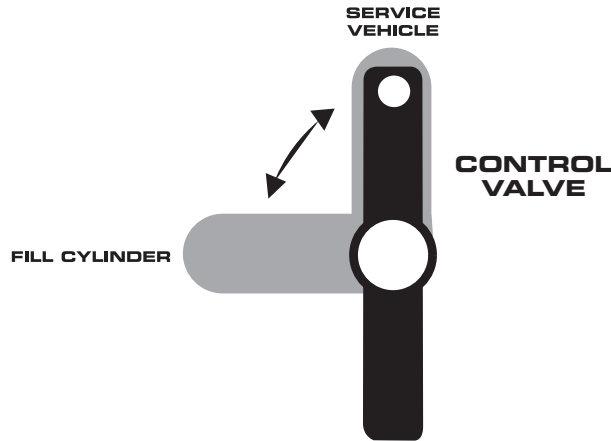

Figure 36. Control Valve Positions

For each service being performed, always make certain to fill the cylinder with the specific type of ATF required by the vehicle to be serviced. Once *Preparation For Use* has been completed, a typical service consists of the following procedures in the order presented.

1. Fill Cylinder Function
2. Connecting to the Vehicle
3. Fluid Exchange Function

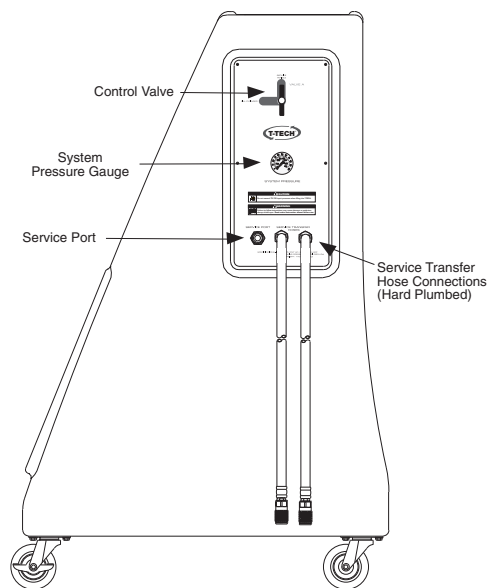

Figure 37. TT100 Side View

## Fill Cylinder Function

The Fill Cylinder function is used to fill the **T-TECH** cylinder with new ATF and empty the cylinder of old ATF.

**CAUTION: Fill cylinder completely.** Air below the piston will result in an incomplete exchange as this air will compress and not move the piston at beginning of the exchange process. (This condition usually occurs only during the initial fill.)

### Using a Bulk Dispenser Gun

To use this method, a bulk dispenser gun (see Figure 38) accessory kit must be used. The accessory kit is an optional kit not supplied with the **T-TECH**. The bulk dispenser gun accessory kit must be ordered separately (Part No. FIT200, see Replacement Parts List).

**CAUTION:** Ensure that your air delivery system does not exceed 75 psi at the point of delivery. Many air systems have a 3:1 or 4:1 pressure ratio – this means you must dial your system down to compensate for the output delivery ratio. Monitor the gauge on the **T-TECH** control panel to ensure that 75 psi is not exceeded.

**CAUTION:** Fill cylinder completely. Air below the piston will result in an incomplete exchange as this air will compress and not move the piston at beginning of the exchange process. If this is the first time your **T-TECH** machine has been filled, there will be air under the piston instead of old ATF. The air must be allowed to exit just as if it were old fluid. See Note on Step 3 below.

1. Determine ATF type needed for your next service.
2. Set CONTROL VALVE (on control panel on the side of the unit) to FILL CYLINDER.
3. Attach a service hose adapter to the end of each service transfer hose.

*Note: Although the used fluid will exit only one service hose when filling the cylinder with new fluid, it is critical that you connect service hose adapters to both service transfer hoses every time you fill the **T-TECH**.*

4. Insert both service hoses into a container suitable for collecting and disposing of old ATF. The container must be capable of holding a minimum of 18 quarts (the full capacity of the **T-TECH** cylinder).

*Note: Always follow your local environmental protection agency guidelines for proper disposal of ATF.*

5. Using the proper fittings that correspond to your dispenser gun, connect the bulk dispenser gun to the CYLINDER FILLING port on the control panel on the side of the **T-TECH** (see Figure 38) .
6. Press the trigger on the bulk dispenser gun. The flow direction for filling new fluid from a bulk dispenser gun is shown in Figure 39.
7. Verify that the pressure gauge on the **T-TECH** control panel does not exceed a reading of 75 lbs.
8. New fluid should begin flowing into the top of the cylinder. An equal amount of used ATF is being displaced and forced out of the **T-TECH** through one of the service hoses and into your designated used-ATF disposal container.
9. Continue the process until the cylinder is filled with the required amount of new ATF.

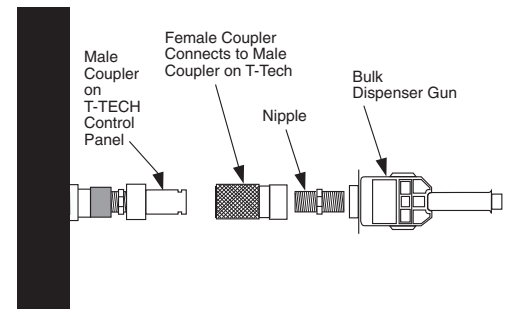

Figure 38. Bulk Dispenser Gun Connection

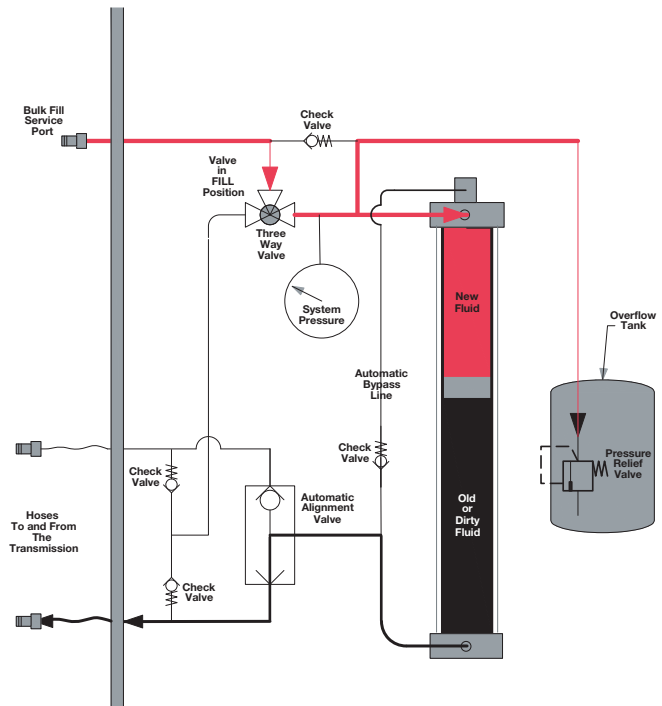

Figure 39. Flow Direction From A Bulk Dispenser Gun

## Connecting to the Vehicle

Connecting to the vehicle for service requires identifying the automatic transmission cooling lines and making the necessary connections to exchange ATF.

### Identifying Cooling Lines

Figure 40 is a diagram of a typical automobile transmission cooling system. Transmission cooling systems are essentially the same from one vehicle to another though they may be routed differently or the fittings might be in slightly different locations. In some systems, both lines will run to the bottom of the radiator – this is found on radiators that have top and bottom tanks. Some cooling systems will have a secondary transmission cooler in addition to the cooler in the radiator (see Figure 41).

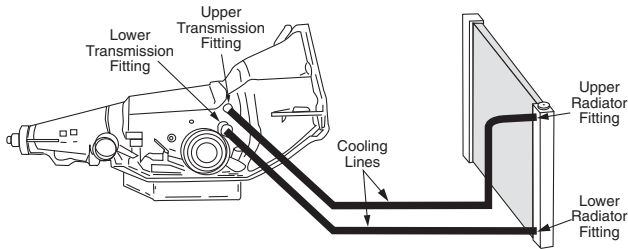

Figure 40. Typical Automobile Cooling System

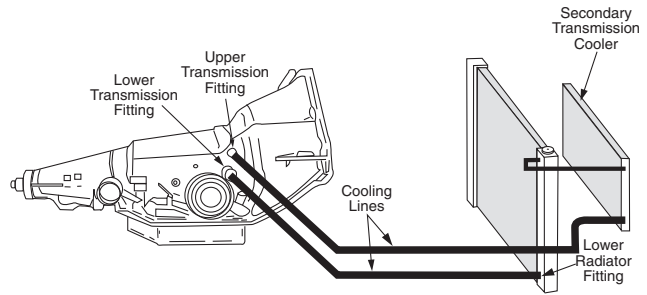

Figure 41. Automobile Cooling System With Secondary Transmission Cooler

### Making Vehicle Service Connections

The fittings required to service ATF vary based on vehicle make, and sometimes from model to model. **Make sure the vehicle is shut off** and cool. Do not open a transmission system that is hot and under pressure. Figure 42 shows some typical hookup locations. Location #1 is the fittings at the transmission. Location #2 is the fittings at the radiator. Location #3 shows a location (typical to foreign vehicles) where a rubber hose changes to a steel tubing line. There must be a removable hose clamp at this location in order to make a connection. Only a few vehicles will be serviced at this location.

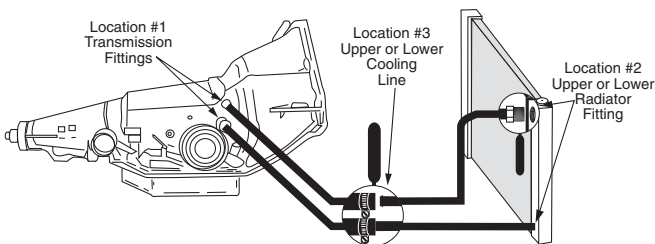

Figure 42. Typical Cooling Hookup Locations

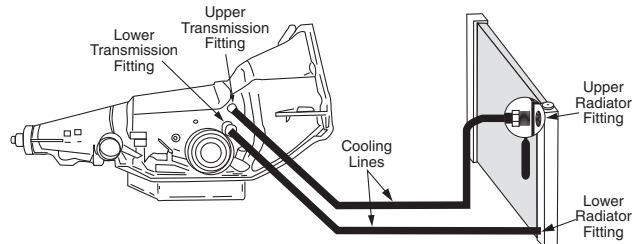

Figure 43. Hookup Top Radiator Line

For the hookup procedure, we will use as an example an illustration that represents a 1992 Chevrolet 4-door Blazer, Figure 43.

1. Always verify that the transmission fluid level is normal before you begin.
2. Look for the easiest spot to break into the transmission system (any existing connection along the entire system can be used, see Figure 42).

*Note: In this vehicle (Chevy Blazer) the top radiator line is determined (for this example) to be the easiest location to make the **T-TECH** connection.*

3. If available, use a transmission cooling line wrench (an open end wrench, flare nut wrench, or adjustable wrench) to remove the cooling line from the radiator (see Figure 43).

- Examine the vehicle fittings and compare them to the fitting chart on the back of the **T-TECH** cabinet door. In this case, a Chevrolet fitting is required and a review of the fitting chart indicates that FIT303 and FIT304 are the correct choices (see Figure 44).
- Connect the male FIT304 fitting into the radiator, as shown in Figure 45.
- Connect the female FIT303 fitting onto the vehicle transmission cooling line as shown in Figure 45.

*Note: The connections only need to be snug fit. Torquing down hard is not required, but they should still be tight enough to keep the connections from leaking. If they begin to leak when service starts, see Troubleshooting.*

- Attach service adapter hoses to each fitting as shown in Figure 46.

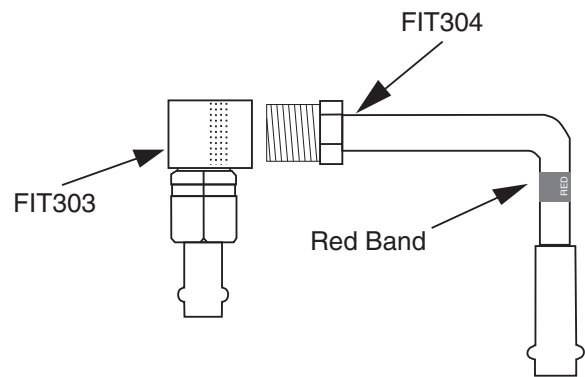

Figure 44. The Correct Fittings Selection

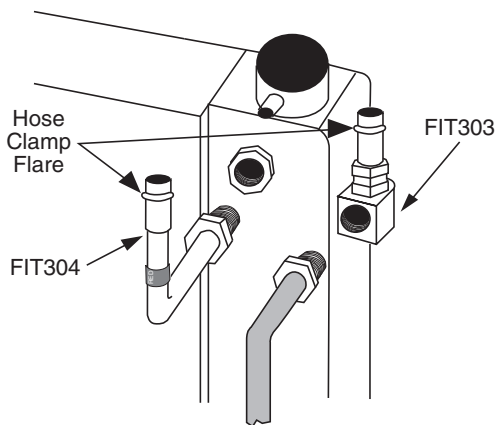

Figure 45. Insert Fittings

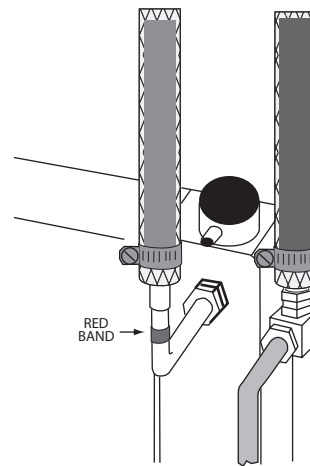

Figure 46. Attach Service Adapter Hoses

- Make certain the hose clamp is tightened on the inside of the hose clamp flare on each fitting (see Figure 45) to keep the hose from coming off.

**CAUTION:** Over tightening the adapter hose clamps will destroy the hose ends over a period of time. Clamp the hoses down with a snug fit only. If they still leak, see *Troubleshooting*.

- Connect a service hose adapter to each service transfer hose (see Figure 47). You are not required to account for fluid flow when making this connection. The **T-TECH** machine will sense the vehicle's fluid direction and adjust so that the used ATF from the vehicle is always coming into the bottom of the **T-TECH** cylinder and the new ATF is moved out of the top of the **T-TECH** cylinder and into the vehicle transmission. When the transfer hoses have been connected, the system should look like the illustration in Figure 47.

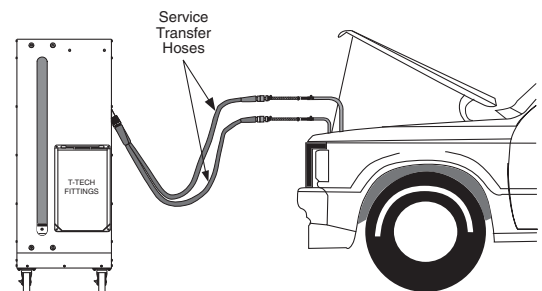

Figure 47. Connection Complete



## Fluid Exchange Function

Use this function to exchange old automatic transmission fluid (ATF) with new ATF.

1. With the **T-TECH** auto align feature, you need not be concerned about which service transfer hose is connected to the transmission cooling line or to the radiator because flow direction is controlled through the **T-TECH** unit.
2. Set CONTROL VALVE (on the **T-TECH** control panel) to SERVICE VEHICLE (pointing straight up).
3. Start the vehicle. The pressure gauge (on the **T-TECH** control panel) should read between 10 and 75 lbs., depending on the vehicle being serviced. If the pressure is below 10 lbs. and the piston is not moving in an upward direction, see *Troubleshooting*.
4. The piston should begin to move upward in the cylinder (see Figure 49). Notice that the old fluid enters the cylinder under the piston. The old fluid pumped in by the vehicle transmission pushes up on the piston, which in turn pushes an equal amount of new fluid out the top of the cylinder and into the vehicle.
5. You may notice some fluid between the O-rings on the piston (see Figure 50). The presence of new ATF is normal between the O-rings for lubrication of the piston and O-rings. However, if old ATF passes by the O-rings and into the new ATF, O-ring replacement is needed. (See *Troubleshooting*)
6. When the desired amount (vehicle system capacity) of ATF has been exchanged, or the fluid in the service hose coming from the vehicle runs clear, turn the vehicle OFF, remove all hoses and hose connections and reconnect the vehicle transmission cooling lines.
7. Restart the vehicle.
8. Check the ATF level in the vehicle. (Check the vehicle dipstick for proper procedure. Some vehicles require the transmission be in PARK and some in NEUTRAL.)
9. Inspect the vehicle fittings for leaks.
10. Fluid exchange is complete.

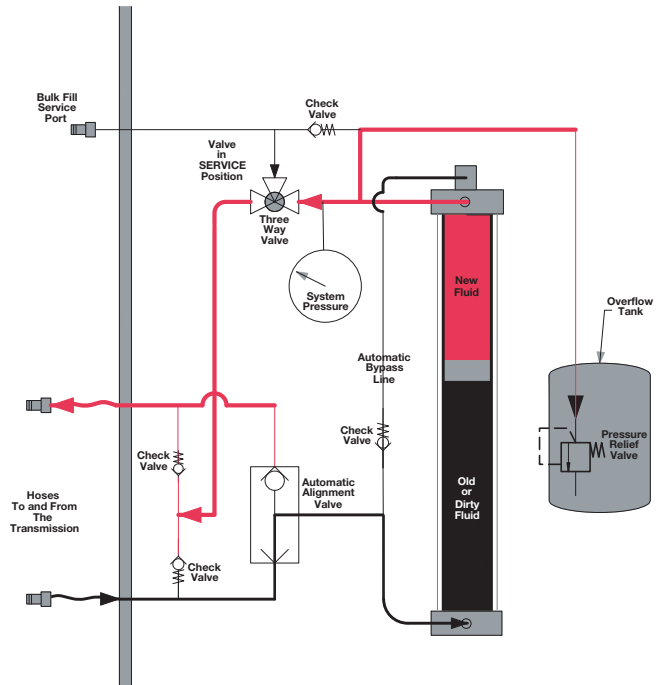

Figure 48. Vehicle Service Flow Direction

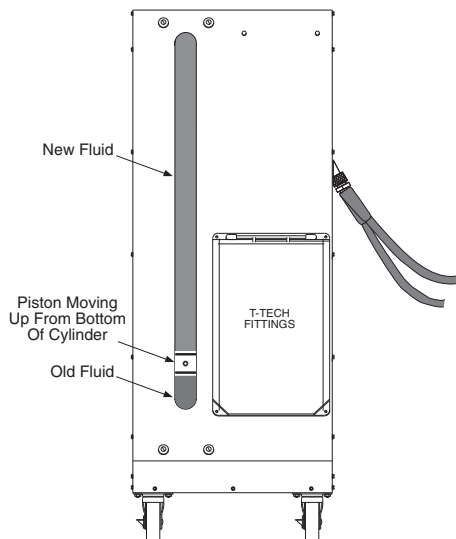

Figure 49. Piston Movement

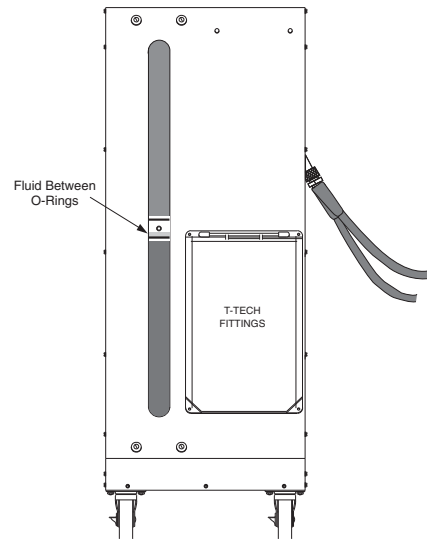

Figure 50. Fluid Between O-Rings

## Bypass Feature

The **T-TECH** bypass feature allows new ATF to loop within the vehicle when the exchange is complete and the piston is at the top of the cylinder. This feature allows the operator to walk away (work on something else, etc.) when the machine is running, without being concerned about service completion. When the piston reaches the top of the cylinder (old ATF has displaced all of the new ATF), the bypass feature is automatically engaged. This causes the new fluid to be forced into a loop through the vehicle and the **T-TECH** unit. The bypass will continue until stopped when the operator turns the vehicle OFF.

## Replace Existing New ATF with Different New ATF

Use this procedure to replace a new fluid type that is already in the cylinder with another type of new fluid needed to perform a current service (e.g. the cylinder is currently filled with DEXRON III but you need to service a Chrysler that uses MOPAR+ fluid).

To accomplish this task, the piston will be pushed to the top of the cylinder to force any existing new ATF into a clean storage container so the fluid can be reused. See Figure 61.

1. Set CONTROL VALVE to SERVICE VEHICLE.
2. Attach a service hose adapter to each service transfer hose.
3. Insert one service hose adapter into a clean container to save the fluid that is to be removed from the cylinder.
4. Insert your air nozzle into the open end of the other service hose adapter.
5. Apply air pressure (air pressure should be above 10 psi but should not exceed 20 psi on the system pressure gauge).
6. The machine will sense the pressure and the piston should begin to rise. As the piston nears the top of the cylinder, ease back on the air pressure.
7. When the piston reaches the top of the cylinder, hold the air nozzle and service hose adapter in a waste container with the service adapter pointing away from any personnel. Pressurized air and possibly some ATF will be expelled out of the end of the service hose adapter when the air is released and the line hose is removed.
8. Release the air pressure and remove the nozzle from the service hose adapter.
9. Refill the cylinder with new ATF fluid of the type required to perform the service according to FILL CYLINDER FUNCTION. Make sure to fill the cylinder until the cylinder is completely full of ATF to avoid any air pockets under the piston.

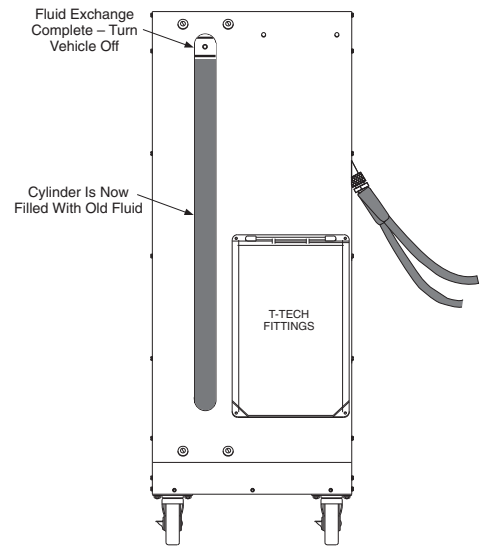

Figure 51. Exchange Of Fluids Complete

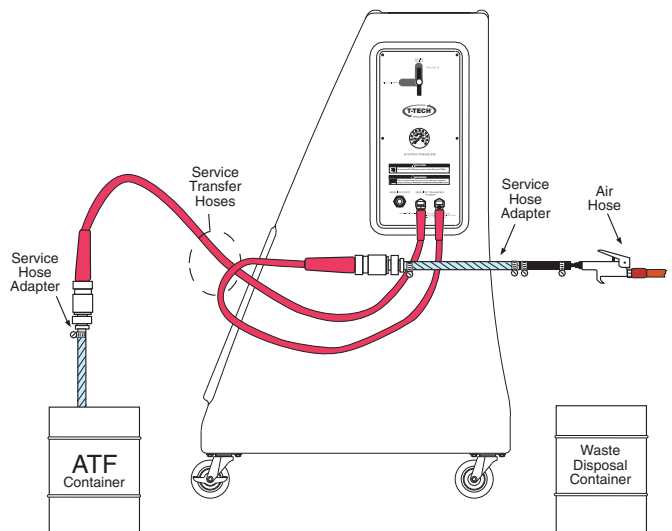

Figure 52. Exchange New Fluids

# MAINTENANCE

## General

There is no periodic maintenance necessary on the T-TECH unit.

## Troubleshooting

The following troubleshooting flow charts are provided for solutions to problems that may occur during various operating processes.

### Vehicle Service

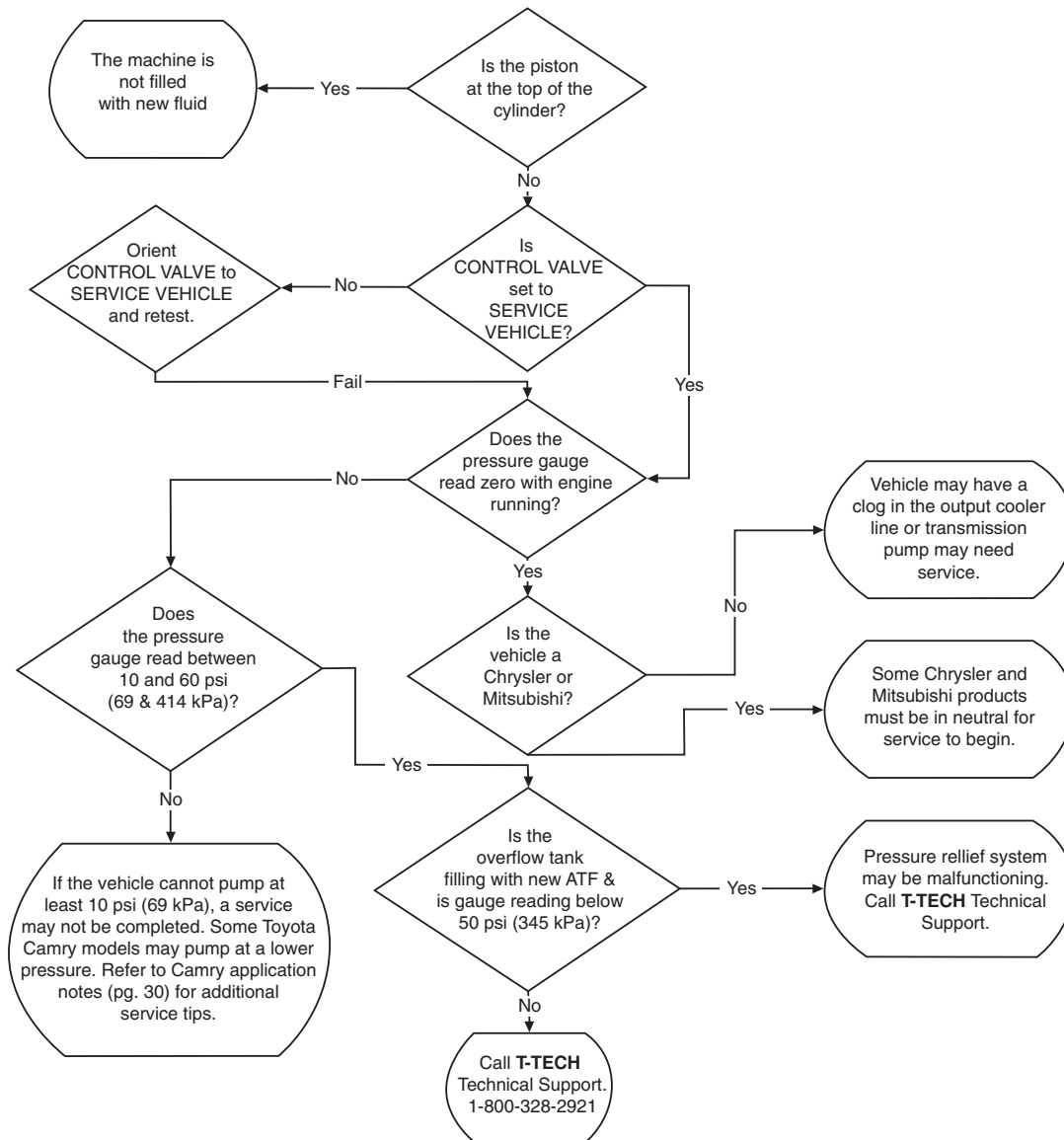



# T-TECH APPLICATION NOTES

## General

The information in the following pages provides information for specific **T-TECH** applications. The information provided here is listed alphabetically by vehicle manufacturer and vehicle type.

**CAUTION:** Some automobile manufacturers use snap type connectors on transmission cooling lines. To avoid damaging the radiator, never remove the fitting from the radiator but rather use the proper disconnect tool to remove line from fitting.

If a tool is not available, follow the cooler lines to a point where the line and a rubber hose meet and disconnect at that point. Follow all directions for a proper service.

Typical vehicles utilizing snap type cooler line connections are Ford Taurus, late model Ford pick-ups and SUV's, Dodge trucks, most GM products after 2000 and Chrysler vehicles after 2004.

## BMW

### BMW FIT402

BMW Kit No. FIT402 looks like the Mercedes-Benz Fitting No. FIT322 but is somewhat larger.

**CAUTION:** These fittings are a matched set and must be kept together in the small plastic box marked FIT402.

#### Instructions

FIT402 is installed on the BMW as illustrated in Figure 53.

### BMW 500 Series FIT407

**CAUTION:** These fittings are a matched set and must be kept together in the small plastic box marked FIT407.

#### Instructions

1. The BMW 500 Series FIT407 utilizes an O-ring to seal the line instead of the bullet style fitting used on smaller BMW models.
2. Use the fittings in FIT407 the same way as the fittings in FIT402 (see Instructions and Figure 53). Extra O-rings have been included with FIT407.

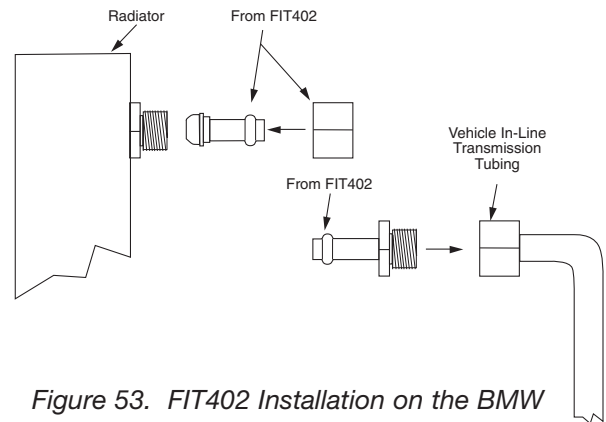

Figure 53. FIT402 Installation on the BMW

## Chrysler

**CAUTION:** Many Chrysler products use rubber hose to connect to the transmission cooler. The hose usually has one or more plastic clips along the length to keep the hose away from pulleys, belts, etc. While doing a **T-TECH** service, it is possible to dislodge the hose from the clips. Closely monitor the security of the clips and hoses during **T-TECH** service to assure that the hose is not cut off by a belt or pulley after the vehicle is returned to customer.

*Note:* A number of Chrysler vehicles, including some Jeeps, require the vehicle to be in neutral while the engine is running to develop vehicle transmission pressure. The **T-TECH** exchange process simply will not work unless vehicle transmission pressure is developed.

Many late model Chrysler vehicles utilize Internal Quick Connect (IQC) Fittings to join the transmission cooler line to the radiator. For application instructions related to these vehicles, see GM Instructions, page 27.

## Dodge Dakota (to 1997) and some Ram FIT403

*Note: Whenever using special fittings from FIT403, start them by hand and slowly tighten enough to prevent leaks.*

Use FIT403 on the 1995 to 1997 Dakota (see FIT412 for post 1997) and some Ram models.

The quick connect fitting in the Dodge Dakota transmission cooling line (at the radiator) requires a removal tool that is not supplied. FIT403 is installed on the Dakota as illustrated in Figure 54.

**CAUTION:** *These fittings are a matched set and must be kept together in the small plastic box marked FIT403.*

### Instructions

1. Remove the transmission cooling line with the line removal tool.
2. Insert the small fitting into the receptacle and continue pushing until the plastic clip in the receptacle engages the fitting.
3. Install a service adapter hose on the small fitting and another on the vehicle transmission cooling line. Clamp both in place and start service.

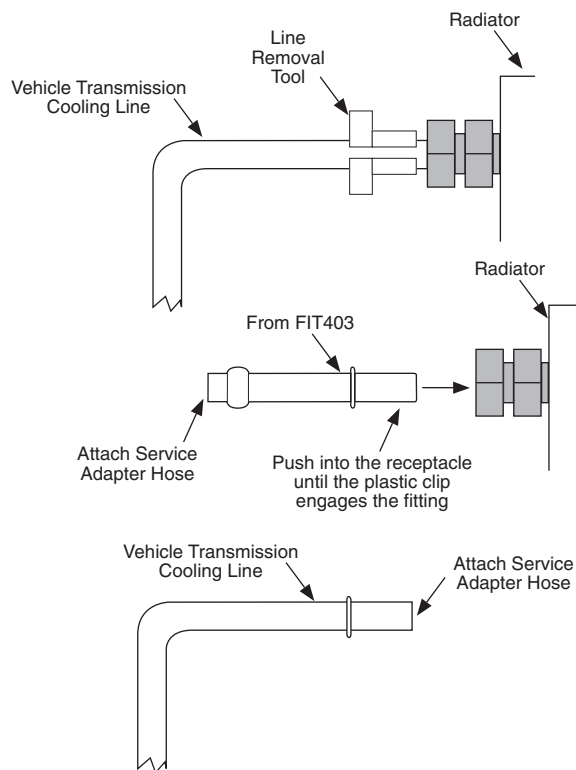

Figure 54. FIT403 Installation on Dodge Dakota

## Dodge Ram [Pre-2004 Assorted Gasoline engines only]

**CAUTION:** *It is VERY easy to damage the radiator threads on these vehicles. The radiator fittings on assorted 1995-2004 DODGE RAM TRUCKS are brass and the threads are 9/16-24 ultra fine cut. The threads can be stripped as the technician removes the line. We recommend that you access the line either at the transmission or at the hose clamp connection (if available). If you decide to remove the radiator fitting, use the following steps to help eliminate damaging the fitting. Careful handling of the vehicle is the responsibility of the technician. **T-TECH** will not accept any liability for vehicle damage.*

1. Spray the fitting with penetrating oil.
2. Break the nut loose with a wrench.
3. Finish removing by hand only.
4. Replace the nut by hand only.

*Note: Whenever using special fittings from FIT403 start them by hand and only tighten enough to prevent leaks.*

The quick connect fitting in the Dodge Ram transmission cooling line (at the radiator) requires a removal tool that is not supplied. The FIT403 male fitting goes on the end of the steel line and the female fitting goes on the radiator (see Figure 55).

**CAUTION:** *These fittings are a matched set and must be kept together in the small plastic box marked FIT403.*

### Instructions

1. Remove the transmission cooling line with the line removal tool.
2. Insert the small FIT403 fitting into the receptacle and continue pushing until the plastic clip in the receptacle engages the fitting (see Figure 55).
3. Insert the large FIT403 fitting onto the transmission cooling line (see Figure 55).
4. Install a service adapter hose on each fitting. Clamp both in place and start service.

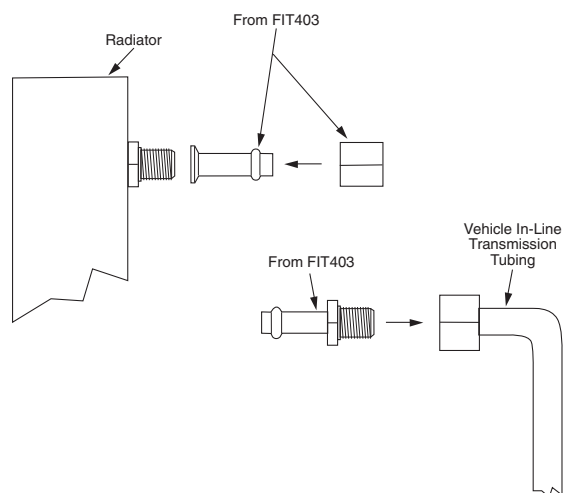

Figure 55. FIT403 Installation on some Dodge Ram

## Dodge Ram [Pre-2001 Turbo Diesel]

### Instructions

1. The Dodge Turbo Diesel uses the large quick connect fitting in FIT403, but it is easier to locate the 1/2 inch hose connection near the bottom of the radiator and use 1/2 inch fittings FIT321 and FIT324 with hose clamps.

## Some Dodge Durango and Dakota 1997-2004 FIT412

FIT412 is a three part fitting (see Figure 56).

### Instructions

1. Remove the transmission cooling line from the radiator connection.
2. Connect one of the elbow fittings to the fitting attached to the radiator.
3. Install one of the service hose adapters to the other end of the elbow fitting and secure in place with one of the hose clamps.
4. Insert the small double ended fitting into the vehicle in line transmission tubing connector.
5. Connect the second elbow fitting to the other end of the small double ended fitting.
6. Install a second service hose adapter to the other end of the elbow fitting and secure in place with one of the hose clamps. Start service.

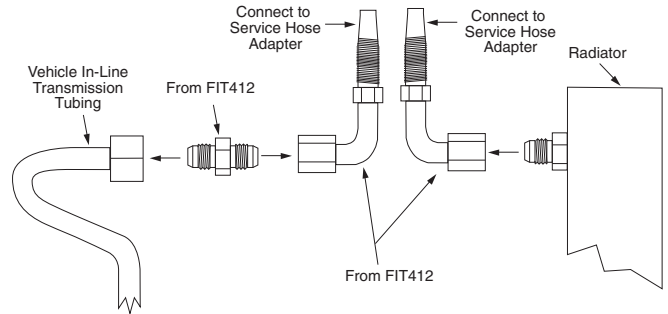

Figure 56. FIT412 Installation On Dodge Durango

## Jeep Grand Cherokee FIT405

**CAUTION:** These fittings are a matched set and must be kept together in the small plastic box marked FIT405.

FIT405 contains a special close radius fitting to make connection to Grand Cherokee and some other models of Jeep easier. This fitting will fit behind the battery box for the radiator connection (see Figure 57).

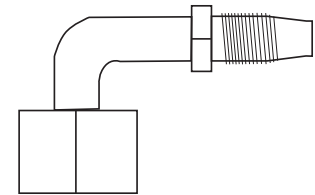

Figure 57. FIT405 For Installation On Jeep Grand Cherokee

## General Ford Notes

**CAUTION:** Use caution when servicing Ford products. Some Taurus models use a very large snap-in fitting that actually holds the transmission cooler in the radiator. **DO NOT REMOVE this fitting.** Remove, instead, the transmission cooling line from the fitting. The following method can be used wherever snap-in style fittings are encountered.

1. Removing the transmission cooling line from this fitting requires the use of a tool such as the LISLE #37000 A/C AND FUEL LINE DISCONNECT SET.

**CAUTION:** The snap-in fittings contain O-rings that seal the transmission cooling line to the receptacle. If the O-ring is broken, the fitting will leak. The only way to fix this problem is to replace the entire receptacle (Ford part #F3D3-7D273-A) along with a metal safety clip (Ford part #F3D2-73465-A) that must also be reinstalled.

*Note: Whenever using special fittings from FIT403, start them by hand and only tighten enough to prevent leaks.*

2. After the transmission cooling line has been released, insert the fitting from FIT403 into the radiator fitting.
3. Attach one of the standard fittings (such as FIT321) or a service adapter hose to the transmission cooling line for service.



## Ford Contour FIT408

FIT408 is a two part fitting that requires an O-ring seal to the transmission line.

**CAUTION:** These fittings are a matched set and must be kept together in the small plastic box marked FIT408.

### Instructions

1. Remove the transmission cooling line from the radiator.
2. Attach the female portion of FIT408 to the transmission cooling line.
3. Attach the male portion of FIT408 to the radiator (see Figure 58).

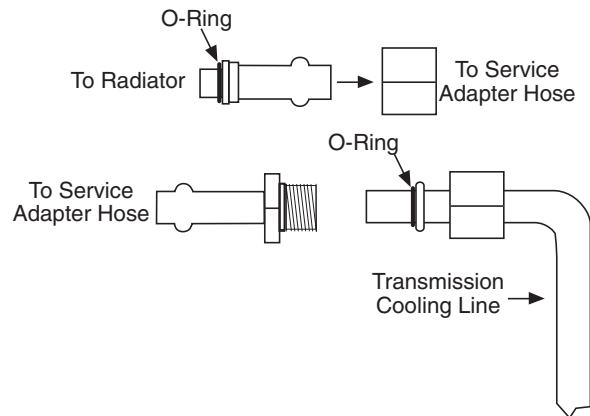

Figure 58. FIT408 Installation on Ford Contour

## Ford Escort FIT401

**CAUTION:** These fittings are a matched set and must be kept together in the small plastic box marked FIT401.

### Instructions

1. Remove the vehicle bolt, fitting and crush washers from the radiator.
2. Install the **T-TECH** female half to the stock bolt and washers.
3. Install the **T-TECH** male half into the radiator using the white nylon gasket (supplied) (see Figure 59).
4. After **T-TECH** service is complete, remove the fittings and store in FIT401, reinstall factory parts and start the engine. Check for leaks and fluid quantity.

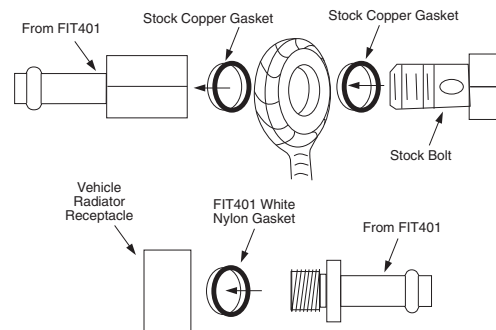

Figure 59. FIT401 Installation on Ford Escort

## Ford Explorer

Many 2001 to 2006 Ford Explorer and Mercury Mountaineer models have an internal thermostat that controls the flow of the fluid to the cooler. This thermostat solenoid remains closed until the vehicle reaches proper operating temperature (140°F). There is no bypass or pressure relief mechanism in this solenoid that can be forced open. This situation will result in low or no flow of transmission fluid to and though the **T-TECH**, causing delays in service times.

The following procedure is recommended to improve service times on the above vehicles:

1. Connect the **T-TECH** to the vehicle (varies by model).
2. Start the vehicle, set the parking brake and with foot on brake, place in neutral increasing engine speed to 1600 RPM.
3. When the transmission fluid reaches 140°, the solenoid will open and the fluid will start to flow through the cooler lines and to the cooler.
4. Continue to keep a foot on the brake, maintain the engine at 1600 RPM and the vehicle in neutral to maintain optimum transmission fluid temperature and flow.
5. If no fluid flow occurs, use a non-contact thermometer and check the temperature of the transmission pan. If not at 140° raise the engine speed to 1900 RPM to increase the transmission temperature.
6. If the fluid temperature is at or above 140° and fluid does not flow, stop the process. In some cases, the thermostat or solenoid valve may be defective (not allowing fluid flow) and need servicing. Inspect the transmission fluid condition and if the fluid is extremely burnt it may indicate a defective thermostat or solenoid. This must be remedied before a service can be performed.
7. To ensure correct fluid level, always check the fluid level prior to vehicle leaving the bay. Refer to Sealed Transmission service guidelines below.



Many 2002 to 2006 Ford Explorers and Mercury Mountaineer models feature a sealed transmission system with no automatic transmission dipstick. The instructions below outline the proper service techniques for fluid level check on such models using the **T-TECH** FIT516 Ford Fill Adapter Kit.

*Suggested Service Tools: Oil suction gun, 3/16" Allen or T-30 Torx wrench and a **T-TECH** FIT516 Ford Fill Adapter Kit.*

1. Ensure the vehicle is sitting level. Start the vehicle and warm the transmission to operating temperature (120° to 140°F).
2. With foot on the brake, slowly place shift selector in each gear position momentarily returning to park when complete.
3. With engine still running, access the underside of the vehicle and locate the transmission drain plug. Using the appropriate tool, remove the center plug from the drain plug, holding the drain plug in place.
4. If fluid runs out of center of the drain plug, allow to drain to a slow drip and replace the center plug. The vehicle fluid level is correct.
5. If no fluid runs out, thread the FIT516 Ford Fill Adapter into the center plug opening. Using an oil suction gun, inject 1 pint of correct ATF into vehicle through the Ford Fill Adapter and remove the oil suction gun.
6. If fluid runs out, follow Step #4, first removing the FIT516 Ford Fill Adapter. If no fluid drains out, inject another .25 pint of fluid following above instructions. Repeat until fluid drains out. Follow Step 4 above, first removing the FIT516 Adapter.
7. Shut-off the engine. Fluid check is complete.

*Note: The transmission pan will hold 3 quarts of ATF when filled to correct level, vehicle is running and sitting level.*

## **F-Series Trucks**

**CAUTION:** Late model F-Series trucks feature a Quick Connect fitting at the the radiator. **DO NOT REMOVE this fitting.** Remove, instead, the transmission cooling line from the fitting. The following method can used be wherever this Quick Connect fitting is encountered.

### **F-150 Instructions**

1. Remove the transmission cooling line from this radiator fitting using the 3/8" Ford Quick Disconnect Removal Tool (Part No. FIT512).
2. After the transmission cooling line has been released, insert the fitting from FIT414 into the radiator fitting.
3. Attach a service adapter hose to the FIT414 fitting and to the transmission cooling line for service.

### **F-250 Instructions**

1. Remove the transmission cooling line from this radiator fitting using the 1/2" Ford Quick Disconnect Removal Tool (Part No. FIT513).
2. After the transmission cooling line has been released, insert the fitting from FIT415 into the radiator fitting.
3. Attach a service adapter hose to the FIT415 fitting and to the transmission cooling line for service.

## Ford Taurus and Windstar FIT403

FIT403 must be installed at the transmission in Ford Taurus and Windstar and in the Mercury Sable. For some 1993 and newer vehicles, use the larger diameter fitting in FIT403 (see Figure 60) with FIT321 used as the female side. For some 1993 and older use the smaller diameter fitting in FIT403.

**CAUTION:** These fittings are a matched set and must be kept together in the small plastic box marked FIT403.

**CAUTION:** Do not remove the quick connect receptacle located on the radiator of the Ford Windstar, Taurus, and Mercury Sable. On some of those vehicles, the receptacle fitting holds the cooler inside the radiator tank. Removing the receptacle will allow radiator coolant to leak out.

The quick connect may be released. The transmission cooler line can be removed and fitted with the appropriate **T-TECH** fitting. However, most of the vehicles leave very little room to work so the recommended fitting hookup is at the transmission itself. The cooling at the transmission can be removed and fitted with the appropriate **T-TECH** fitting.

### Instructions

1. Remove the transmission cooling line.
2. Insert the appropriate FIT403 fitting (see Figure 60) into the receptacle and continue pushing until the plastic clip in the receptacle engages the fitting.
3. Install a service adapter hose on the FIT403 fitting and another on the vehicle transmission cooling line, using FIT321. Clamp both in place and start service.

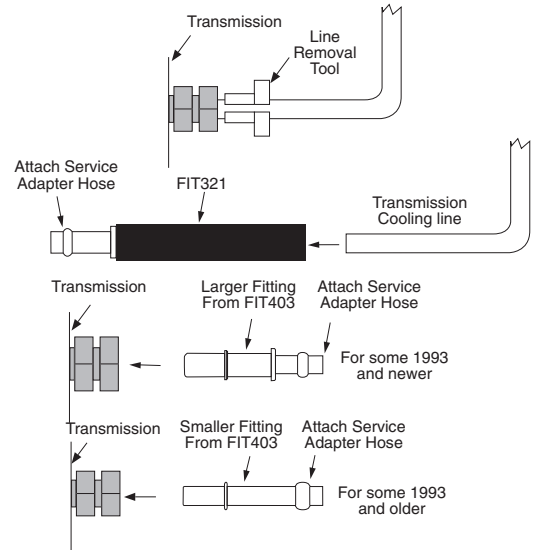

Figure 60. FIT403 Installation on Ford Taurus, Ford Windstar & Mercury Sable

## Ford Windstar FIT406

FIT406 fittings (Figure 61) have two thin grooves cut into the flats to identify them.

**CAUTION:** These fittings are a matched set and must be kept together in the small plastic box marked FIT406.

Windstar, Taurus, Dodge Dakota, some Ford 1981 and up and many GM and Chrysler models use various snap-in connectors for the cooling lines. Field experience has found the most effective way to remove these fittings is by the procedure identified below.

**CAUTION:** Do not remove the quick connect receptacle located on the radiator of the Ford Windstar, Taurus, and Mercury Sable. On some of those vehicles, the receptacle fitting holds the cooler inside the radiator tank. Removing the receptacle will allow radiator coolant to leak out. The quick connect may be released. The transmission cooler line can be removed and fitted with the appropriate **T-TECH** fitting. However, most of the vehicles leave very little room to work so the recommended fitting hookup is at the transmission itself. The cooling at the transmission can be removed and fitted with the appropriate **T-TECH** fitting.

### Instructions

1. Spray WD-40 or similar oil into and around the fitting. This lubricates the captive o-ring.
2. Remove the transmission cooling line from the radiator.
3. Attach FIT406 Female to the cooling line.
4. Attach FIT406 Male to the radiator or transmission.
5. Install a service adapter hose on each fitting, clamp both in place and start service.

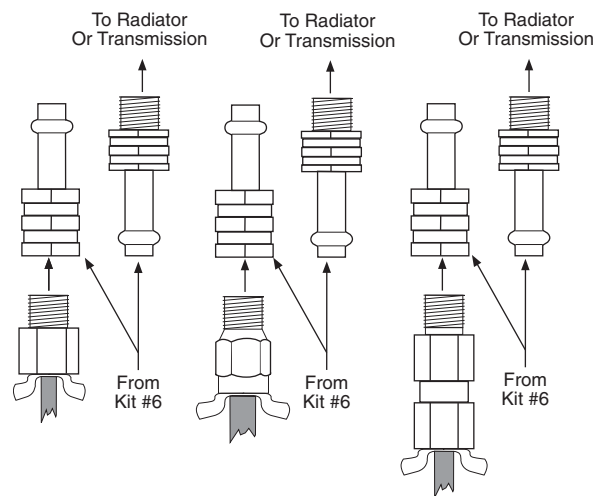

Figure 61. FIT406 Installation on Ford Windstar

## Mercury Mountaineer

See *Ford Explorer* Instructions.

## Mercury Mystique FIT401

**CAUTION:** *These fittings are a matched set and must be kept together in the small plastic box marked FIT401.*

### Instructions

1. Remove the stock bolt, the fitting and the crush washers from the radiator.
2. Install the **T-TECH** female half to the stock bolt and washers.
3. Install the **T-TECH** male half into the radiator using the white nylon gasket (supplied).
4. After **T-TECH** service is complete, remove the fittings and store in case FIT401, reinstall factory parts and start the engine. Check for leaks and fluid quantity.

## Mercury Sable FIT403

*Note: Whenever using special fittings from FIT403 start them by hand and only tighten enough to prevent leaks.*

FIT403 must be installed at the transmission in the Mercury Sable. Use the larger fitting in FIT403 (see Figure 54) along with FIT321.

See *Ford Taurus and Windstar FIT403* Instructions.

## General Motors

Special Fittings Kit FIT404 and FIT416 are to be used on any GM vehicle utilizing 3/8" "E" clip snap fittings. This includes Blazers and Astro vans from the mid-90's through all 2006 GM vehicles (except Allison equipped vehicles, see pg. 28).

1. Locate a transmission cooler line where it attaches to the radiator. Remove the plastic cover, sliding back onto the cooler line, exposing the "E" clip.
2. Using a small hook, awl or screwdriver, remove the "E" clip from the radiator fitting. (This clip will need to be reinstalled to hold the FIT404/FIT416 male adapter in place during the ATF exchange.)  
*Note: An alternative is to use a **T-TECH** GM 3/8" Quick Disconnect Tool (Part No. FIT514) to disengage the cooler line without removing the "E" clip, ensuring the clip is not damaged during installation.*
3. Remove the cooler line from the radiator fitting and reinsert the "E" clip back onto the radiator fitting.
4. Insert the male fitting (FIT404 or FIT416, depending on your access requirements) until it engages in the radiator fitting.
5. Connect a service adapter hose onto the **T-TECH** fitting and onto the transmission cooler line.
6. When service is complete, reverse the installation procedure. Always replace the "E" clip with a new one (Part No. FIT510) prior to connecting the transmission cooler line back into the radiator fitting.  
*Note: The "E" clips are easily stretched or bent when removed. The design of the "E" clips utilizes 3 pressure points to hold a line in place. If any of these points are compromised, the line may come out of the radiator, causing fluid leaks and the transmission to run low on fluid. **ALWAYS** install a new clip prior to final connection of the cooler line back into the radiator fitting.*
7. After reassembly is complete, test on the cooler line to ensure connection is secure. Reinstall the plastic cover back over the fitting to keep out dirt and debris.
8. Check vehicle for leaks and proper fluid levels.

## Allison Series 1000 Special Fitting Kit FIT413 (Optional)

**CAUTION: T-TECH Automatic Transmission Fluid Exchange Machines are designed to bleed Automatic Transmission Fluid (ATF) into the overflow container if system pressures exceed 85 PSI. Please note that the FIT413 Kit cannot be used in conjunction with T-TECH Model No. JB100 because of the pressure limitations of that early model.**

When servicing an Allison 1000 transmission, it is critical to warm the vehicle up prior to service, as this transmission system can exhibit pressures up to 125 PSI when cold. After the fluid reaches normal operating temperature, the system pressure will drop to approximately 70 PSI and service can be performed.

Never exceed idle when servicing the Allison 1000 as doing so will raise the system pressure in excess of 85 PSI, forcing open the **T-TECH** pressure overflow valve and directing ATF into the overflow tank.

### Instructions

*Note: During the 2003 model year, GM changed the design of the fittings used to connect the Allison 1000 cooler line to the radiator. As a result, you will encounter different fitting requirements for these vehicles, based on model year. Your new T-TECH FIT413 Special Fittings Kit is designed to enable service, regardless of model year.*

Your **T-TECH** FIT413 Kit contains 3 hose assemblies. The female hose assembly utilizes a universal fitting and will adapt to both the old and new Allison models. There are 2 male hose assemblies: the “short” nose male hose assembly is designed to fit older Allisons while the “long” nose hose assembly will fit the newer Allisons. Care must be taken to match the correct male fitting to the application to avoid connection issues and leaking of fluid. As a double-check, always compare the transmission cooler line fitting to the FIT413 male hose assembly to ensure proper selection.

1. Locate a transmission cooler line where it attaches to the radiator. Remove the plastic cover, sliding back onto the cooler line, exposing the “E” clip.
2. Using a small hook, awl or screwdriver, remove the “E” clip from the radiator fitting. (This clip will need to be reinstalled to hold the FIT413 male adapter in place during the ATF exchange.)
3. Remove the cooler line from the radiator fitting and match to the corresponding male hose assembly from the FIT413 Kit to ensure that the correct male hose assembly is used for the service.
4. Reinsert the “E” clip back onto the radiator fitting and connect the proper FIT413 male hose assembly.
5. Connect the FIT413 female hose assembly onto the transmission cooler line.
6. When service is complete, reverse the installation procedure. Always replace the “E” clip with a new one (Part No. FIT511) prior to connecting the transmission cooler line back into the radiator fitting.

*Note: The “E” clips are easily stretched or bent when removed. The design of the “E” clips utilizes 3 pressure points to hold a line in place. If any of these points are compromised, the line may come out of the radiator, causing fluid leaks and the transmission to run low on fluid. It is strongly recommended that you install a new clip prior to final connection of the cooler line back into the radiator fitting.*

7. After reassembly is complete, test on the cooler line to ensure connection is secure. Reinstall the plastic cover back over the fitting to keep out dirt and debris.
8. Check vehicle for leaks and proper fluid levels.

## Mazda FIT411

Mazda uses a banjo fitting similar the Ford Escort and Saab 900/9000 except that it is larger, see Figure 62.

**CAUTION: These fittings are a matched set and must be kept together in the small plastic box marked FIT411.**

### Instructions

1. Remove the vehicle stock bolt, donut fitting, and washer from the radiator.
2. Install the female half of special fitting kit FIT411 on the vehicle stock bolt (through the donut fitting) with the removed washer added.

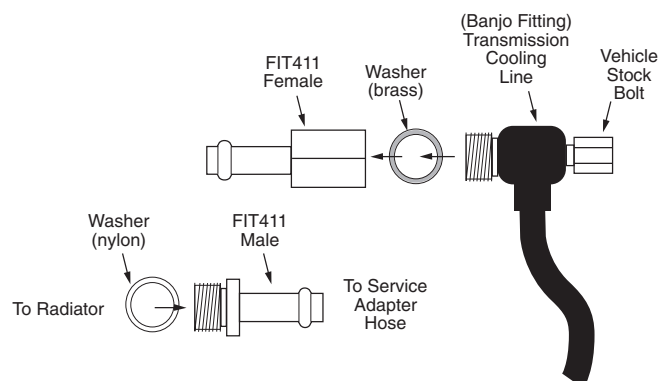

Figure 62. FIT411 Installation On Mazda Vehicles

3. Install the male half of the special fitting FIT411 into the radiator with a supplied nylon gasket.
4. When service is completed, return the fittings to special fittings case.
5. Reinstall factory parts.
6. Start the engine.
7. Check for leaks and fluid quantity.

## Mercedes-Benz Standard Fitting FIT322

The Mercedes-Benz standard fitting FIT322 looks similar to the BMW special fittings FIT402 but is somewhat smaller.

### Instructions

Use the instructions and picture for BMW FIT402.

## Nissan FIT411

Some Nissan models use a banjo fitting similar to the Ford Escort and Saab 900/9000 except that it is larger. See the figure for Mazda FIT411.

**CAUTION:** *These fittings are a matched set and must be kept together in the small plastic box marked FIT411.*

### Instructions

1. Remove the vehicle stock bolt, donut fitting, and washer from the radiator.
2. Install the female half of special fitting kit FIT411 on the vehicle stock bolt (through the donut fitting) with the removed washer added.
3. Install the male half of the special fitting FIT411 into the radiator with a supplied nylon gasket.
4. When service is completed, return the fittings to special fittings case.
5. Reinstall factory parts.
6. Start the engine.
7. Check for leaks and fluid quantity.

## SAAB 900 and 9000 FIT410

**CAUTION:** *These fittings are a matched set and must be kept together in the small plastic box marked FIT410.*

### Instructions

1. Remove the vehicle hollow bolt along with the washers from the radiator.
2. Install the female half of FIT410 (see Figure 63) onto the hollow bolt along with the washers.
3. Install the male half of FIT410 into the radiator with a supplied white nylon gasket.
4. When **T-TECH** service is complete, remove the fittings and return them to FIT410.
5. Reinstall factory parts.
6. Start the engine.
7. Check for leaks and verify fluid quantity.

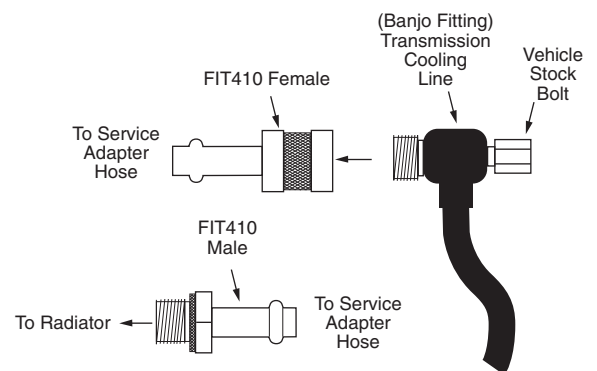

Figure 63. FIT410 Installation On Saab Vehicles

# Toyota

## Toyota Camry

*Note: When servicing Toyota Camry's with 4 cylinder engine, a low line pressure condition may be encountered. This is normal and requires the following steps to perform the service.*

1. With the **T-TECH** connected to the vehicle through a cooler line, start the vehicle.
2. Set the parking brake, with one foot on brake, place the transmission in neutral and increase the engine speed to 1900 RPM. Monitor the exchange process until completed.
3. If the transmission is still not producing the needed pressure for an exchange, increase the engine speed to 2300 RPM. Monitor the exchange process until completed.
4. If the line pressure is still too low to perform a service, stop the exchange and disconnect the **T-TECH**. The vehicle may have other problems that need to be corrected before service can be completed.

## Volkswagen

A fluid exchange service cannot be performed on most Volkswagen automobiles, including Jetta, Golf, Passat and Audi.

**CAUTION:** *These vehicles do not have automatic transmission fluid cooler lines. In some cases, Volkswagen transmission lines may have radiator coolant in them. This is because the heat exchanger is located inside the transaxle.*

## Volvo 850 FIT409

The Volvo 850 uses a fitting that requires special parts to complete a **T-TECH** service.

**CAUTION:** *Some of these fittings are a matched set and must be kept together in the small plastic box marked FIT409.*

### Instructions

1. With an expansion pliers (a common screwdriver, 1/2 inch wide will also work), expand the clip and remove the line and clip from the radiator.
2. Remove the clip from the line.
3. Install a lathe cut ring and an o-ring on the fitting.
4. Install the clip on the FIT409 fitting.
5. Push the fitting and clip into the radiator. The ramps will automatically expand the receptacle on the radiator.
6. Push a service adapter hose over the fitting and clamp down.
7. Push fitting FIT321 over the transmission cooling line and clamp it in place.
8. Attach a service adapter hose to FIT321.
9. When service is complete, return the special fittings to FIT409 (Figure 64) case and FIT321 to the assigned location in the fittings drawer.

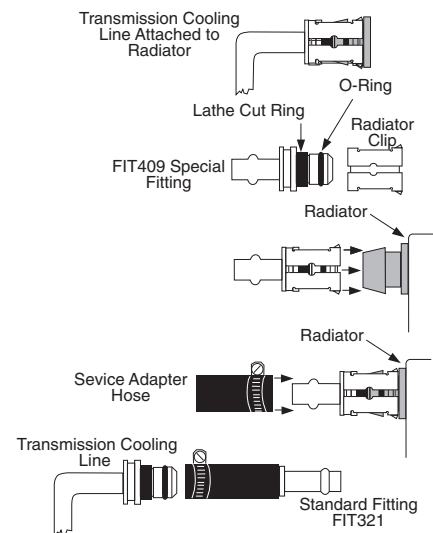
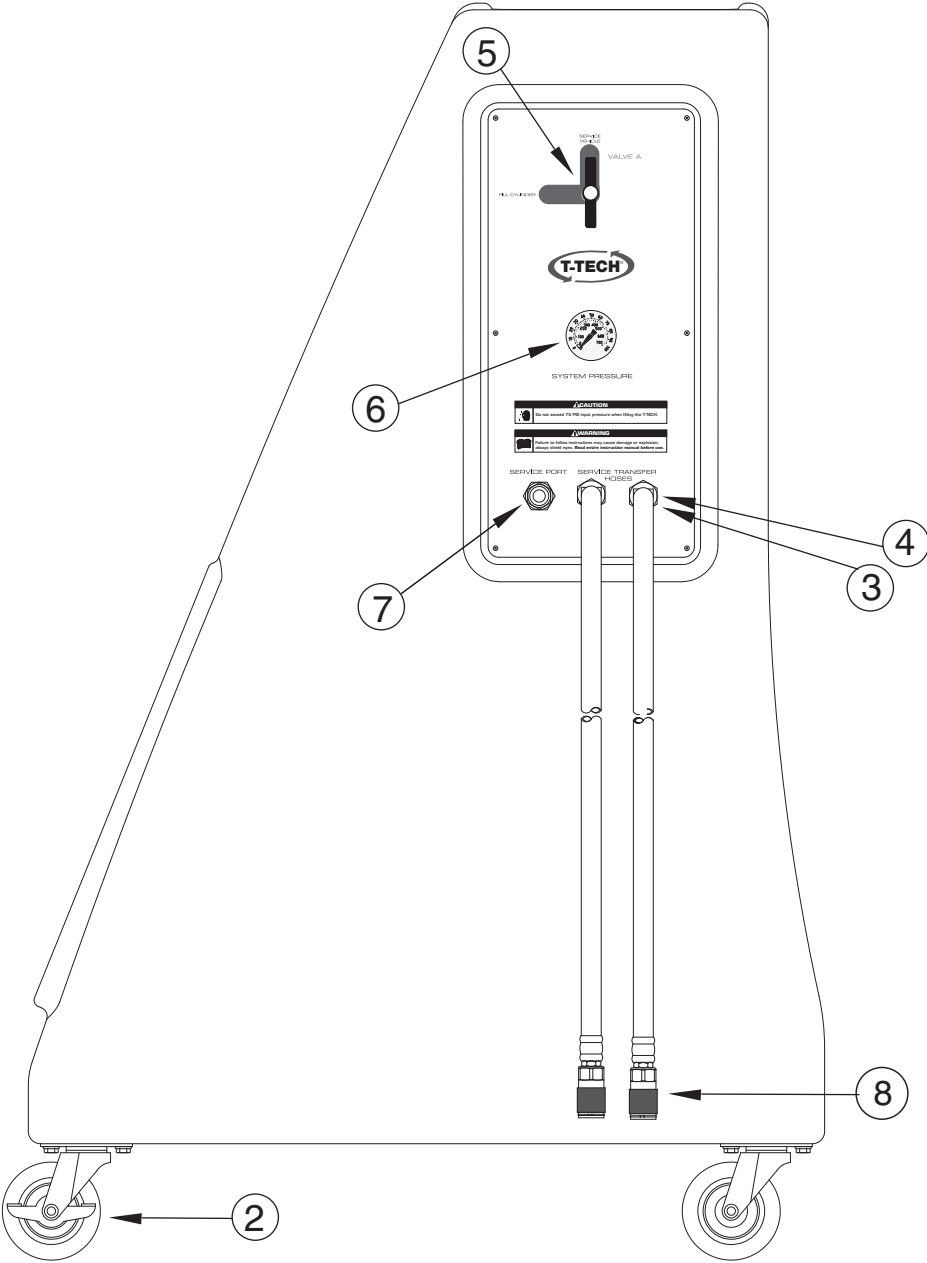

Figure 64. FIT409 Installation On Volvo 850

# REPLACEMENT PARTS LIST

## External Parts List



<b>Item</b>	<b>Description</b>	<b>Part Number</b>
	Transmission Fluid Exchanger, TT100 Model	150-012-000
2	Caster Kit (2 Standard, 2 with Brake)	413-079-666
3	Fitting, Elbow, 45 degree	253-377-666
4	Fitting, Brass	253-376-666
5	Valve Knob	246-433-000
6	Pressure Gauge	251-003-000
7	Quick Connect, Male	COU120
8	Quick Connect, Female	COU110
†	Service Hose Assembly	870-675-000
†	Tubing, Nylon 1/2" outside diameter, 44" length	059-212-044
†	Tubing, Nylon 1/2" outside diameter, 30" length	059-212-030
†	Fitting, Pressure Gauge	253-075-002
†	Service Adapter Hose	SRV100
†‡	Bulk Dispenser Gun Accessory Kit (ATF Adapter)	FIT200

† Items not shown

‡ Optional accessory – must be ordered separately



# REPLACEMENT PARTS LIST CONTINUED

## Internal Parts List

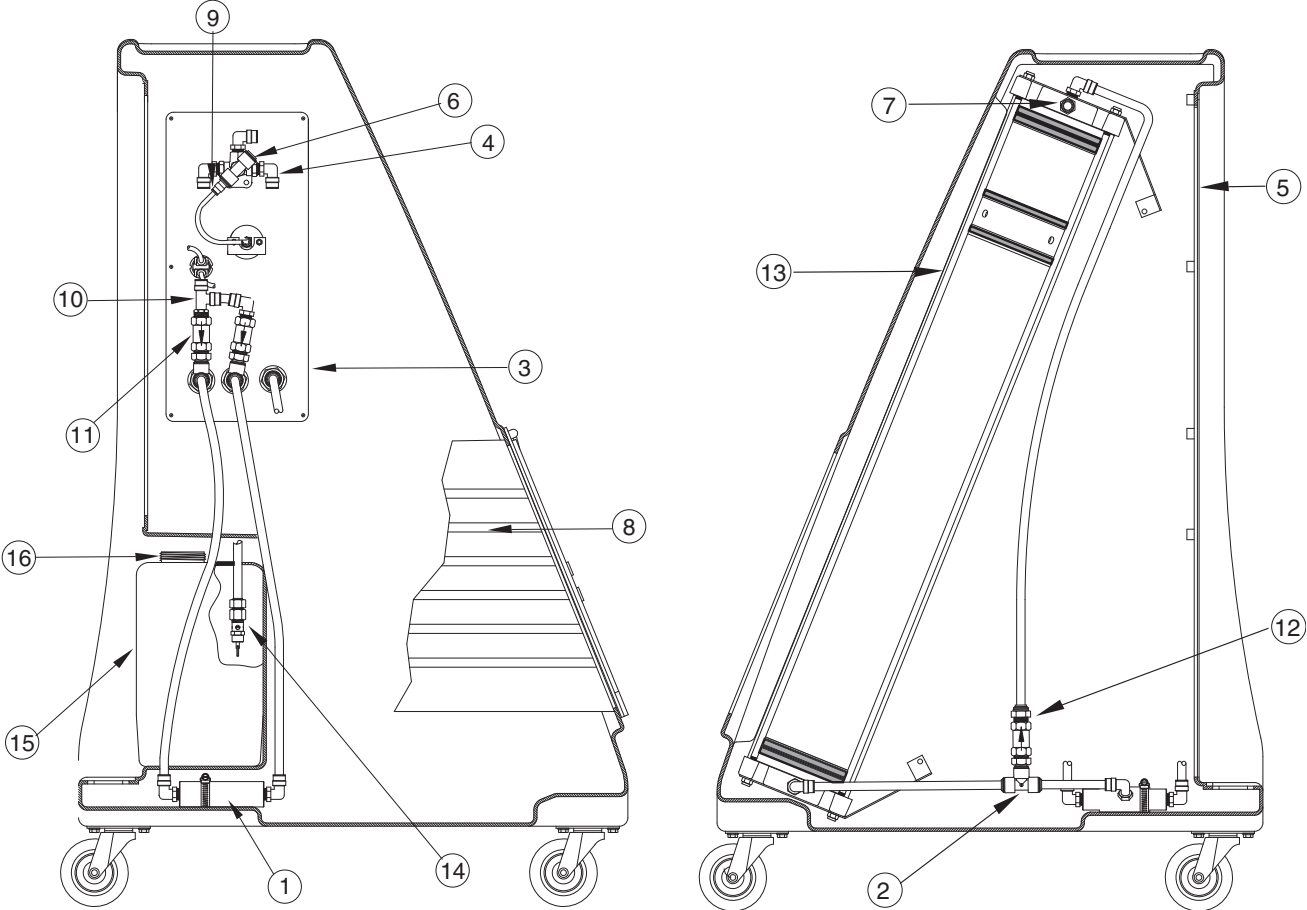

<b>Item</b>	<b>Description</b>	<b>Part Number</b>
1	Shuttle Valve Assembly with fittings	870-868-000
2	Fitting – Tee 1/2 tube	253-304-002
3	Control Panel – TT100	440-665-100
4	Fitting – Elbow 90 Degree 3/8 MPT x 1/2 Tube	253-307-002
5	Panel – Back	440-660-100
6	Valve 4-Way	252-069-000
7	Fitting – 3/8 MPT x 1/2 Tube	253-412-002
8	T-TECH Cabinet Assembly	134-316-000
9	Fitting – Reducer 1/2 stem x 1/4 Tube	253-301-002
10	Fitting – Tee 1/2 MPT x 1/2 Tube	253-415-002
11	Check Valve 1/2 MPT	253-095-666
12	Fitting – 1/2 MPT x 1/2 Tube	253-090-002
13	Cylinder Assembly, Low Resistant	870-010-666
†	Decal for Cylinder	753-830-000
†	Fitting – Elbow 90 degree 1/2 Tube	253-102-002
14	Pressure Relief Valve	870-864-666
15	Overflow Reservoir	314-027-000
16	Reservoir Cap	340-019-000
†	Low Resistance Piston Kit	870-002-666

† Items not shown

## T-TECH Fittings and Tools

Description	Part Number	Description	Part Number
<b>Standard Fittings Assortment</b>	FIT300	<b>Special Fittings Assortment</b>	FIT110
<i>Includes:</i>		<i>Includes:</i>	
GM Large Female	FIT301	Ford Escort/Nissan/Mazda	FIT401
GM Large Male	FIT302	BMW	FIT402
GM Small Female	FIT303	Ford Taurus/Full Size Dodge Trucks	FIT403
GM Small Male	FIT304	3/8 Quick Connect, GM/Chrysler	FIT404
Chrysler Large Male	FIT305	Jeep/Chrysler	FIT405
Chrysler Large Female	FIT306	Ford/Dodge	FIT406
Chrysler Small Male	FIT307	BMW 5 and 3 Series	FIT407
Chrysler Small Female	FIT308	Ford Contour/Mercury Mystique	FIT408
Ford Large Female	FIT309	Volvo	FIT409
Ford Large Male	FIT310	Saab	FIT410
Ford Small Female	FIT311	Large Mazda	FIT411
Ford Small Male	FIT312	Durango/Dakota	FIT412
Older Ford Quick Coupler Male	FIT314		
Universal 1/4 x 3/8 Female Adapter	FIT315		
Universal 1/4 x 3/8 Male Adapter	FIT316		
Universal 5/16 x 3/8 Female Adapter	FIT317		
Universal 5/16 x 3/8 Male Adapter	FIT318		
Universal 3/8 x 3/8 Male Adapter	FIT319		
Universal Female 3/8 Barb	FIT320		
Universal 1/2 x 3/8 Female Adapter	FIT321		
Mercedes-Benz Fitting	FIT322		
Universal Male 3/8 Barb	FIT323		
Universal 1/2 x 3/8 Male Adapter	FIT324		
<b>Additional Fittings, Tools and Accessories</b>			
Allison Series 1000 Fitting Kit (3 pcs.)	FIT416		
3/8 Quick Connect, Ford	FIT414		
1/2 Quick Connect, Ford	FIT415		
90° 3/8 Quick Connect, GM/Chrysler	FIT416		
Replacement "E" Clips (20) for FIT404/FIT416	FIT510		
Replacement "E" Clips (20) for FIT413	FIT511		
3/8 Ford Quick Disconnect Tool Kit (3)	FIT512		
1/2 Ford Quick Disconnect Tool Kit (3)	FIT513		
3/8 GM/Chrysler Quick Disconnect Tool Kit (5)	FIT514		
1/2 GM/Chrysler Quick Disconnect Tool Kit (5)	FIT515		
Ford Fill Adapter Kit	FIT516		
Replacement Center Drain Plugs (10) for Ford Fill Adapter Kit	FIT517		

# PLUMBING DIAGRAM

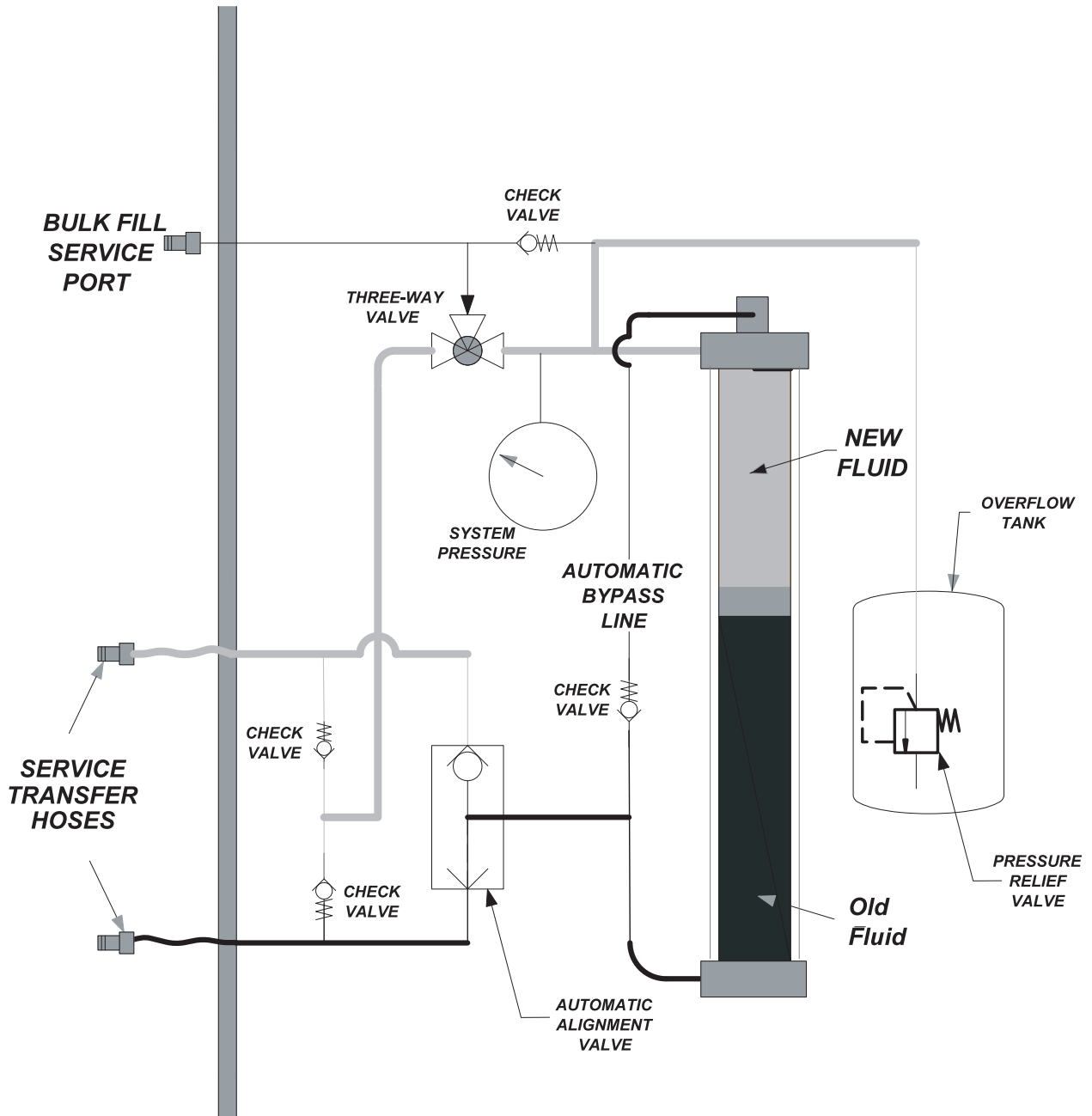

# LIMITED WARRANTY

Clore Automotive, LLC warrants your **T-TECH** to be free from defects in material and workmanship for a period of one year from the date of sale to the original user or consumer purchaser. If your **T-TECH** malfunctions or fails within the 12 month warranty period because of a defect in material or workmanship, we will repair it without charge.

This warranty is in lieu of all other express warranties. The duration of any implied warranty, including but not limited to any implied warranty of merchantability or fitness for a particular purpose, made in respect to your **T-TECH** is limited to the period of the express warranty set forth above.

This warranty excludes and does not cover defects, malfunctions, or failures of your **T-TECH** which were caused by repairs made by an unauthorized person, mishandling, modifications, normal wear, unreasonable use or damage to the **T-TECH** while in your possession.

In no event shall Clore Automotive, LLC be liable for consequential or incidental damages. Some states do not allow limitations on the length of the implied warranty or the exclusion or limitation of incidental or consequential damages so the above limitations or exclusions may not apply to you. This warranty gives you specific legal rights and you may also have other rights which vary from state to state.



## TT100 USER'S GUIDE

**READ CAREFULLY  
BEFORE OPERATING UNIT!**

**WARNING:** This product contains chemicals, including lead, known to the State of California to cause cancer, birth defects and other reproductive harm. *Wash hands after handling.*

Clore Automotive • Kansas City, MO 64161 • [www.t-techonline.com](http://www.t-techonline.com) • 913.310.1050

© 2006 Clore Automotive 842-400-010